

**PRO FASTENING
SYSTEMS, INC.**

WWW.PROFASTENING.COM



**PRODUCT
CATALOG**

SUPPLYING CONTRACTORS SINCE 1980



PRO FASTENING SYSTEMS, INC. STOCKS AND SELLS COMMERCIAL GRADE FASTENERS, ADHESIVES, SEALANTS, AND TOOLS, SERVING MANY COMMERCIAL CONSTRUCTION TRADES. WE'VE BEEN AT IT **SINCE 1980**, SUPPLYING TOP TIER PRODUCTS, ALWAYS WITH OUTSTANDING SERVICE.

OUR 4 MIDWEST LOCATIONS EACH OFFER A FULLY STOCKED WAREHOUSE, INSIDE AND OUTSIDE SALES SUPPORT, AND LOCAL DELIVERY TO YOUR SHOP OR JOBSITE. ADDITIONALLY, WE SHIP NATIONWIDE, UTILIZING OUR NETWORK OF MANUFACTURING PARTNERS AND OUR OWN WAREHOUSES.

MORE THAN JUST GREAT PRODUCTS FROM TOP VENDORS, PRO FASTENING SYSTEMS HAS BEEN BUILT ON SUPERIOR SERVICE. WE ARE IN THE SHOP EARLY TO SERVE THE TRADES. REAL HUMANS WILL ANSWER THE PHONE WHEN YOU CALL. OUR EXPERIENCED OUTSIDE SALES STAFF IS AVAILABLE AND READY TO VISIT YOUR SHOP OR JOBSITE, AND FIND SOLUTIONS TO MAKE YOUR JOBS RUN BETTER.

CONTACT THE PRO'S AND LET US KNOW HOW WE CAN HELP YOU!



TECHNICAL REFERENCE..... 4



FASTENERS..... 6



SEALANTS..... 12



COMMERCIAL ROOFING..... 22



ROOF COATINGS..... 36

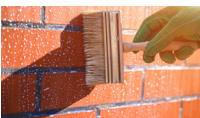

BUILDING ENVELOPE..... 38



RIVETS..... 44



CONCRETE FASTENING..... 46



DRYWALL PRODUCTS..... 50



HARDWARE..... 52



SAFETY GEAR..... 54



ACCESSORIES AND TOOLS..... 56



INDEX..... 63

FASTENER TECHNICAL REFERENCE

SELF-DRILLING FASTENER SELECTION BREAKDOWN

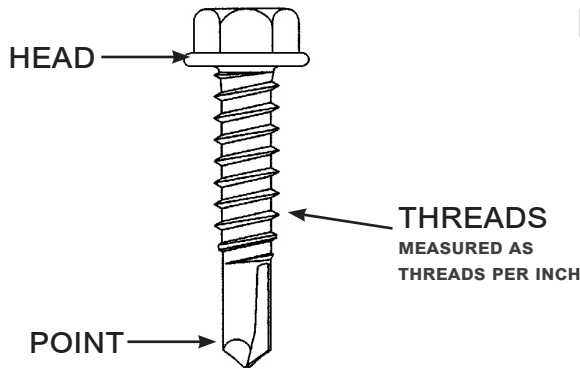

FASTENER DESCRIPTION BREAKDOWN

12 - 14 X 1 1/4" HWH TEKS 3

↑ DIAMETER ↑ THREADS PER INCH ↑ LENGTH ↑ HEAD STYLE ↑ DRILL POINT

DRILL AND TAP CAPACITY CHARTS

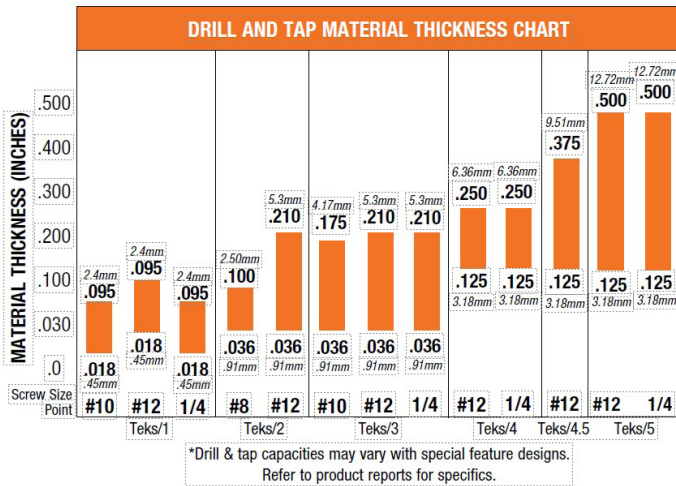

| THREAD DIAMETER | DECIMAL EQUIVALENT |
|-----------------|--------------------|
| #6 | .140 |
| #7 | .150 |
| #8 | .160 |
| #9 | .180 |
| #10 | .190 |
| #11 | .200 |
| #12 | .210 |
| #13 | .230 |
| #14 | .240 |
| 1/4 | .250 |
| #17 | .286 |

| COMMON SHEET STEEL GAUGES | DECIMAL Eq. INCHES | DECIMAL Eq. MM |
|---------------------------|--------------------|----------------|
| 30 | .012 | .30 |
| 28 | .015 | .38 |
| 26 | .018 | .45 |
| 24 | .024 | .61 |
| 22 | .030 | .76 |
| 20 | .036 | .91 |
| 18 | .048 | 1.21 |
| 16 | .060 | 1.52 |
| 14 | .075 | 1.90 |
| 12 | .105 | 2.65 |
| 10 | .134 | 3.42 |
| 3/16 | .187 | 4.77 |
| 1/4 | .250 | 6.36 |
| 1/2 | .500 | 12.72 |

BI-FLEX® Bi-Metal Self-Drilling Structural Screws



DRIL-FLEX® Structural Drill Screws

Drilling and Tapping Capacity (Maximum Material Thickness)

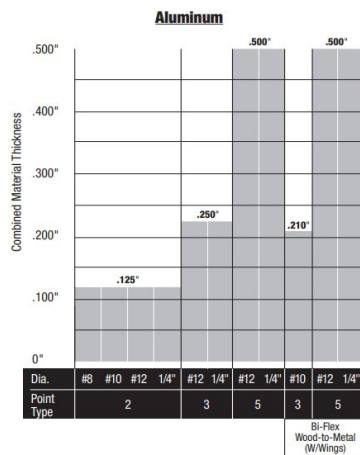
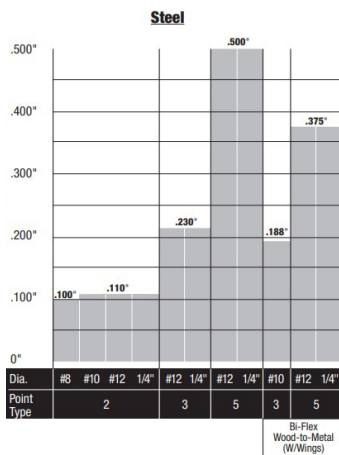

Drilling and Tapping Capacity (Maximum Material Thickness)*

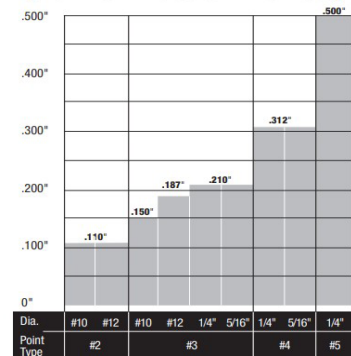

FASTENER MATERIALS, COATINGS, AND INSTALLATION

FASTENER MATERIAL BREAKDOWN

Carbon Steel: The base material for the majority of non-stainless fasteners.

Alloy Steel: The base material for structural self-drilling screws, like Dril-Flex®.

410 Stainless Steel: This alloy has good corrosion resistance along with high strength and hardness.

300 Series Stainless Steel: Classified as austenitic, and offers impressive corrosion resistance and high-strength.

FASTENER HEAD STYLES

HEX WASHER HEAD (HWH)



FLAT HEAD



MODIFIED TRUSS

(LATH HEAD OR ROUND WASHER HEAD)



PAN HEAD



PANCAKE HEAD



WAFFER HEAD



FASTENER COATING BREAKDOWN

Zinc: Protects metal by forming a physical barrier of protection.

Climaseal®: Climaseal (ITW Buildex) is a high quality metal filled thermoset coating. Climaseal has been uniquely formulated to react and form a complete long life protection to provide the optimum in corrosion resistance properties. Climaseal is self sacrificing to the base substrate if penetrated or damaged. Fasteners coated with Climaseal exhibit excellent resistance most forms of abrasion and torque.

Climacoat®: Climacoat (ITW Buildex) is a gray organic coating developed to protect the fastener with a tough anti-corrosive film. Its fully cross linked matrix system provides an excellent mar and chip resistant film. Climacoat is applied in an electro-coating process.

Stalgard®: Stalgard (DeWalt/ELCO) is a multilayer, high corrosion resistant protective coating. Stalgard has been specifically engineered to provide high durability and optimal performance in construction applications that are serious and challenging.

MAXIMUM RECOMMENDED INSTALLATION RPM

| Diameter | RPM |
|----------|------|
| #6 | 2500 |
| #8 | 2500 |
| #10 | 2500 |
| #12 | 2500 |
| #12* | 1800 |
| 1/4" | 1800 |
| 5/16" | 1200 |

* #12 diameter self-drilling screws with a #4, #4.5, or #5 point should be driven at maximum of 1800 RPM

THIS SECTION IS FOR
GENERAL REFERENCE
ONLY. PLEASE REFER TO
THE MANUFACTURERS
WEBSITE FOR PRODUCT
SPECIFIC INFORMATION,
OR CONTACT YOUR PRO
FASTENING SYSTEMS
REP FOR HELP.



NEED HELP SELECTING THE RIGHT PRODUCT? CALL US!

FASTENERS



PF FLYERS - MEDIUM DUTY DRILL SCREWS

HEAVY DUTY DRILL SCREWS - DRIL-FLEX® DRILL SCREWS

BI-FLEX® DRILL SCREWS - IN-HOUSE PAINTING

LOW PROFILE HEAD FASTENERS

LIGHT GAUGE METAL TO WOOD

SPECIALTY FASTENERS - SELF-TAPPERS

MEDIUM DUTY SELF-DRILLING SCREWS



PF Flyers 10-16 X 3/4" TEKS® 3

TEKS® 3, Extra High HWH w/Serrations, Zinc

Stock in the following size:

10-16 X 3/4" (5000/box)

Forged Pan Head Drill Screws

Self-drilling #2 Point, PPH, Zinc plated

Stock in the following sizes:

| | |
|---------------|----------------|
| 8-18 X 1/2" | 10-16 X 1/2" |
| 8-18 X 3/4" | 10-16 X 3/4" |
| 8-18 X 1" | 10-16 X 1" |
| 8-18 X 1 1/4" | 10-16 X 1 1/4" |
| 8-18 X 1 1/2" | 10-16 X 1 1/2" |
| 8-18 X 2" | 10-16 X 2" |
| | 10-16 X 3" |

Forged Flat Head Drill Screws

Self-drilling #2 Point, PFH, Zinc plated

Stock in the following sizes:

| | |
|---------------|----------------|
| 8-18 X 1/2" | 10-16 X 1" |
| 8-18 X 3/4" | 10-16 X 1 1/4" |
| 8-18 X 1" | 10-16 X 1 1/2" |
| 8-18 X 1 1/4" | 10-16 X 2" |
| 8-18 X 1 1/2" | 10-16 X 3" |
| 8-18 X 2" | |



Buildex Medium Duty TEKS®

TEKS® 3, HWH, Climaseal Coating

Stock in the following sizes:

| | | |
|----------------|----------------|-----------------|
| 10-16 X 1/2" | 12-14 X 3/4" | 1/4-14 X 3/4" |
| 10-16 X 5/8" | 12-14 X 1" | 1/4-14 X 1" |
| 10-16 X 3/4" | 12-14 X 1 1/4" | 1/4-14 X 1 1/4" |
| 10-16 X 1" | 12-14 X 1 1/2" | 1/4-14 X 1 1/2" |
| 10-16 X 1 1/4" | 12-14 X 2" | 1/4-14 X 2" |
| 10-16 X 1 1/2" | 12-14 X 2 1/2" | 1/4-14 X 2 1/2" |
| 10-16 X 2" | 12-14 X 3" | 1/4-14 X 3" |
| 10-16 X 2 1/2" | | 1/4-14 X 4" |
| 10-16 X 3" | | 1/4-14 X 5" |
| | | 1/4-14 X 6" |



Forged Medium Duty Self Drillers

Self-Drilling #2 or 3 Point, HWH, Zinc Plated

Stock in the following sizes:

| | | |
|----------------|----------------|-----------------|
| 10-16 X 1/2" | 12-14 X 3/4" | 1/4-14 X 3/4" |
| 10-16 X 5/8" | 12-14 X 1" | 1/4-14 X 1" |
| 10-16 X 3/4" | 12-14 X 1 1/4" | 1/4-14 X 1 1/4" |
| 10-16 X 1" | 12-14 X 1 1/2" | 1/4-14 X 1 1/2" |
| 10-16 X 1 1/4" | 12-14 X 2" | 1/4-14 X 2" |
| 10-16 X 1 1/2" | 12-14 X 2 1/2" | 1/4-14 X 2 1/2" |
| 10-16 X 2" | 12-14 X 3" | 1/4-14 X 3" |
| 10-16 X 2 1/2" | | 1/4-14 X 4" |
| 10-16 X 3" | | 1/4-14 X 5" |
| | | 1/4-14 X 6" |



410 Stainless Steel Self Drillers

Self-Drilling #3 Point, HWH, 410 Stainless Steel

Stock in the following sizes:

| | | |
|----------------|----------------|-----------------|
| 10-16 X 1/2" | 12-14 X 3/4" | 1/4-14 X 3/4" |
| 10-16 X 5/8" | 12-14 X 1" | 1/4-14 X 1" |
| 10-16 X 3/4" | 12-14 X 1 1/4" | 1/4-14 X 1 1/4" |
| 10-16 X 1" | 12-14 X 1 1/2" | 1/4-14 X 1 1/2" |
| 10-16 X 1 1/4" | 12-14 X 2" | 1/4-14 X 2" |
| 10-16 X 1 1/2" | 12-14 X 2 1/2" | 1/4-14 X 2 1/2" |
| 10-16 X 2" | 12-14 X 3" | 1/4-14 X 3" |
| | 12-14 X 4" | 1/4-14 X 4" |
| | | 1/4-14 X 5" |
| | | 1/4-14 X 6" |



Buildex TEKS® Maxiseal®

TEKS® 3, HWH, Integrated Washer, Climaseal Coating

Stock in the following sizes:

| | | |
|--------------|----------------|-----------------|
| 10-16 X 3/4" | 12-14 X 3/4" | 1/4-14 X 3/4" |
| | 12-14 X 1" | 1/4-14 X 1" |
| | 12-14 X 1 1/4" | 1/4-14 X 1 1/4" |
| | 12-14 X 1 1/2" | 1/4-14 X 1 1/2" |



Buildex TEKS® w/Bonded Washer

TEKS® 3, HWH, Bonded EPDM Washer, Climaseal

Stock in the following sizes:

| | | |
|----------------|----------------|-----------------|
| 10-16 X 3/4" | 12-14 X 3/4" | 1/4-14 X 1" |
| 10-16 X 1 1/2" | 12-14 X 1" | 1/4-14 X 1 1/4" |
| | 12-14 X 1 1/2" | 1/4-14 X 2" |
| | 12-14 X 2" | |
| | 12-14 X 3" | |



410 Stainless Steel With Washer

Self-Drilling #3 Point, HWH, 410 Stainless Steel, Stainless Washer

Stock in the following sizes:

| | | |
|----------------|----------------|-----------------|
| 10-16 X 3/4" | 12-14 X 3/4" | 1/4-14 X 3/4" |
| 10-16 X 1" | 12-14 X 1" | 1/4-14 X 1" |
| 10-16 X 1 1/4" | 12-14 X 1 1/4" | 1/4-14 X 1 1/4" |
| 10-16 X 1 1/2" | 12-14 X 1 1/2" | 1/4-14 X 1 1/2" |
| 10-16 X 2" | 12-14 X 2" | 1/4-14 X 2" |
| | 12-14 X 2 1/2" | 1/4-14 X 2 1/2" |
| | 12-14 X 3" | 1/4-14 X 3" |
| | 12-14 X 4" | 1/4-14 X 4" |
| | | 1/4-14 X 5" |
| | | 1/4-14 X 6" |



Buildex SCOTS®

TEKS® 2 or 3, HWH, 300 Series Stainless Cap, Integrated Washer, Climaseal Coating

Stock in the following sizes:

| | |
|----------------|-----------------|
| 12-14 X 1" | 1/4-14 X 1 1/4" |
| 12-14 X 1 1/4" | |
| 12-14 X 1 1/2" | |



Buildex TEKS® 1

TEKS® 1, HWH, Climaseal Coating

Stock in the following sizes:

| |
|---------------|
| 1/4-14 X 7/8" |
|---------------|



Buildex TEKS® 1 Maxiseal®

TEKS® 1, HWH, Integrated Washer, Climaseal Coating

Stock in the following sizes:

| |
|---------------|
| 1/4-14 X 7/8" |
|---------------|



410 Stainless Steel #1 Point

Self-Drilling #1 Point, HWH, 410 Stainless Steel

Stock in the following sizes:

| |
|---------------|
| 1/4-14 X 7/8" |
|---------------|



410 Stainless #1 Point W/Washer

Self-Drilling #1 Point, HWH, 410 Stainless Steel, Stainless Washer

Stock in the following sizes:

| |
|---------------|
| 1/4-14 X 7/8" |
|---------------|



Buildex TEKS® 1 SCOTS®

TEKS® 1, HWH, 300 Series Stainless Cap, Integrated Washer, Climaseal Coating

Stock in the following sizes:

| |
|-----------------|
| 1/4-14 X 7/8" |
| 1/4-14 X 1 1/8" |

HEAVY DUTY SELF-DRILLING SCREWS



Buildex TEKS® 5 Fasteners

TEKS® 5, HWH, Climaseal® Coating

Stock in the following sizes:

| | |
|----------------|-------------|
| 12-24 X 1 1/4" | 1/4-28 X 3" |
| 12-24 X 1 1/2" | 1/4-28 X 4" |
| 12-24 X 2" | 1/4-28 X 5" |
| | 1/4-28 X 6" |
| | 1/4-28 X 8" |



Forged Heavy Duty Self Drillers

#5 Point, HWH, EPDM Washer, Zinc Plated

Stock in the following sizes:

| | |
|----------------|-------------------------|
| 12-24 X 1 1/4" | 12-24 X 1 1/4" W/Washer |
| 12-24 X 1 1/2" | 12-24 X 1 1/2" W/Washer |
| 12-24 X 2" | 12-24 X 2" W/Washer |
| 12-24 X 3" | 12-24 X 3" W/Washer |



Buildex TEKS® 5.0

TEKS® #5 Point, HWH, Climaseal Coating

Stock in the following sizes:

12-24 X 1 1/4"

New in 2022. Significantly faster drilling



410 Stainless Steel HD

#5 Point, HWH, 410 Stainless, Stainless Washer

Stock in the following sizes:

| | |
|----------------|-------------------------|
| 12-24 X 1 1/4" | 12-24 X 1 1/4" W/Washer |
| 12-24 X 1 1/2" | 12-24 X 1 1/2" W/Washer |
| 12-24 X 2" | 12-24 X 2" W/Washer |



Buildex TEKS® 5 W/Washer

TEKS® 5, HWH, Bonded EPDM Washer, Climaseal Coating

Stock in the following sizes:

| | | |
|----------------|-------------|-------------|
| 12-24 X 1 1/4" | 1/4-28 X 3" | 1/4-28 X 6" |
| 12-24 X 1 1/2" | 1/4-28 X 4" | 1/4-28 X 8" |
| 12-24 X 2" | 1/4-28 X 5" | |



Buildex SCOTS® TEKS®5

TEKS® 5, HWH, 300 Series Stainless Cap, Integrated Washer, Climaseal Coating

Stock in the following sizes:

12-24 X 2"

DRIL-FLEX® STRUCTURAL DRILL SCREWS



Dril-Flex Structural Drill Screws are dual heat treated self-drilling tapping screws that provide the strength, ductility and resistance to embrittlement required for critical applications. Similar to Grade 5 performance.

Common applications include:

- Steel-to-steel connections
- Aluminum-to-steel connections
- Aluminum-to-aluminum connections
- Wood-to-steel connections



Dril-Flex® PPH Drill Screws

#2 Drill Point, PPH, Stalgard Coating

Stock in the following sizes:

10-16 X 3/4"



Dril-Flex® Structural Drill Screws

#3 Drill Point, HWH, Stalgard Coating

Stock in the following sizes:

| | | |
|----------------|----------------|------------------|
| 10-16 X 3/4" | 12-14 X 1" | 1/4-14 X 1" |
| 10-16 X 1 1/2" | 12-14 X 1 1/2" | 1/4-14 X 1 1/2" |
| 10-16 X 2 1/2" | 12-14 X 2" | 1/4-14 X 2" |
| | 12-14 X 3" | 5/16-18 X 1 1/2" |
| | | 5/16-24 X 2 1/4" |



Dril-Flex® Undercut Drill Screws

#2 Drill Point, Phillips Undercut Flat Head, Stalgard Coating

Stock in the following sizes:

| | |
|----------------|----------------------|
| 12-14 x 1" | 1/4-20 X 3" #4 Point |
| 12-14 X 1 1/4" | 1/4-20 X 4" #4 Point |
| 12-14 X 1 1/2" | |



Dril-Flex® HD Drill Screws

#4 or 5 Drill Point, HWH, Stalgard Coating

Stock in the following sizes:

| | |
|-----------------|------------------|
| 1/4-20 X 1 1/8" | 5/16-24 X 1 1/2" |
| 1/4-20 X 1 1/2" | 5/16-24 X 2" |
| 1/4-20 X 1 3/4" | 5/16-24 X 2 1/4" |
| 1/4-20 X 2" | |
| 1/4-20 X 2 1/2" | |
| 1/4-20 X 3 3/8" | |
| 1/4-20 X 4" | |



Dril-Flex® Wafer Head Drill Screws

#3 Drill Point, Phillips Wafer Head, Stalgard Coating

Stock in the following size:

10-24 X 1 1/4"

BI-FLEX® STRUCTURAL DRILL SCREWS (300 SS HEAD & SHANK)



Bi-Flex structural self-drilling screws feature the corrosion resistance of 300 series stainless steel and the efficiency of self drilling screws.



BI-FLEX® Structural Drill Screws

#2 or 3 Drill Point, HWH, 300 SS Head & Shank, Stalgard Coating

Stock in the following sizes:

| | | |
|----------------|----------------|-----------------|
| 8-18 X 3/4" | 12-14 X 1" | 1/4-14 X 1" |
| 8-18 X 1" | 12-14 X 1 1/4" | 1/4-14 X 1 1/2" |
| 10-16 X 3/4" | 12-14 X 1 1/2" | 1/4-14 X 2" |
| 10-16 X 1" | 12-14 X 2" | 1/4-20 X 1 1/2" |
| 10-16 X 1 1/2" | 12-14 X 2 1/2" | 1/4-20 X 2" |
| | | 1/4-20 X 3" |
| | | 1/4-20 X 4" |

BI-FLEX® HD Drill Screws

#5 Drill Point, HWH, 300 SS Head & Shank, Stalgard Coating

Stock in the following sizes:

| | |
|----------------|-----------------|
| 12-24 X 1 1/2" | 1/4-20 X 1 1/2" |
| 12-24 X 2" | 1/4-20 X 2" |
| | 1/4-20 X 3" |
| | 1/4-20 X 4" |
| | 1/4-20 X 5" |
| | 1/4-20 X 6" |
| | 1/4-20 X 8" |

BI-FLEX® Undercut Drill Screws

#2 Drill Point, Phillips Undercut Flat Head, 300 SS Head & Shank, Stalgard Coating

Stock in the following sizes:

| | |
|----------------|-------------|
| 12-14 x 1" | 1/4-20 X 3" |
| 12-14 X 1 1/4" | 1/4-20 X 4" |
| 12-14 X 1 1/2" | |



BI-FLEX® PPH Drill Screws

#2 Drill Point, PPH, 300 SS Head & Shank, Stalgard Coating

Stock in the following sizes:

| | |
|-------------|--------------|
| 8-18 X 3/4" | 10-16 X 3/4" |
| 8-18 1" | 10-16 X 1" |

BI-FLEX® Pancake Head DS

#2 or 3 Drill Point, Phillips Pancake Head, 300 SS Head & Shank, Stalgard Coating

Stock in the following sizes:

| | |
|---------------------|---------------------|
| 10-16 X 1" #2 Point | 12-14 X 1" #3 Point |
|---------------------|---------------------|

BI-FLEX® Wood to Metal

Phillips Flat W/Wings, 300 SS Head & Shank, Stalgard Coating

Stock in the following sizes:

| |
|----------------------------|
| 10-16 X 1 1/2" #3 Point |
| 12-24 X 2 13/16" #5 Point |
| 1/4-20 X 2 13/16" #5 Point |

CUSTOM IN-HOUSE FASTENER PAINTING



PRO FASTENING SYSTEMS HAS BEEN PAINTING FASTENERS IN-HOUSE FOR OVER 35 YEARS. OUR FASTENERS CAN BE FOUND ON MAJOR STADIUMS, AIRPORTS, AND OTHER HIGH PROFILE JOBS ACROSS THE COUNTRY.

OUR HIGH QUALITY PAINT PROCESS ENSURES DECADES OF LIFE IN THE FIELD.

FROM SMALL JOBS, TO SUPPLYING MAJOR METAL BUILDING MANUFACTURERS, PRO FASTENING SYSTEMS HAS THE CAPABILITY AND THE EXPERIENCE TO ENSURE THE RESULTS YOU DEMAND.

LOW PROFILE HEAD FASTENERS



PROFILERS Drill Screw

TEKS® 3, Pancake Head, Gray SPEX

Stock in the following sizes:

10-16 X 1" 12-14 X 1"



PROFILERS Type A

Type A (Sharp), Pancake Head, Climacoat

Stock in the following sizes:

10-12 X 1"



PROFILERS DS Stainless

#3 Drill Point, Pancake Head, 410 Stainless Steel

Stock in the following sizes:

10-16 X 1" 10-16 X 2"
10-16 X 1 1/2"



PROFILERS Type A Stainless

Type A, Pancake Head, 410 Stainless Steel

Stock in the following sizes:

10-12 X 1"



PROFILERS #14 Drill Screw

#2 Drill Point, Low Profile Head, Long Life Coating

Stock in the following sizes:

14-13 X 1 1/2" 14-13 X 4" 14-13 X 8"
14-13 X 2" 14-13 X 5"
14-13 X 3" 14-13 X 6"



Bi-Metal Stainless PROFILERS DS

#2 Drill Point, Low Profile Head, 316 Stainless Head and Shank, Hardened Carbon Drill Tip

Stock in the following sizes:

14-13 X 1 1/2" 14-13 X 4" 14-13 X 8"
14-13 X 2" 14-13 X 5"
14-13 X 3" 14-13 X 6"



PROFILERS Heavy Duty

#4 Drill point, Low Profile Head, #3 Square Drive, Long Life Coating

Stock in the following sizes:

12-24 X 1 3/8" 12-24 X 4 3/4" 12-24 X 7 3/4"
12-24 X 2 3/4" 12-24 X 5 3/4" 12-24 X 8 3/4"
12-24 X 3 3/4" 12-24 X 6 3/4" 12-24 X 9 3/4"

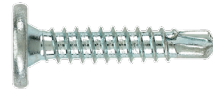

Forged Pancake Head Drill Screws

#3 Drill Point, Phillips Pancake Head, Zinc Plated

Stock in the following sizes:

10-16 X 5/8" 10-16 X 1 1/2"
10-16 X 3/4" 10-16 X 2"
10-16 X 1"

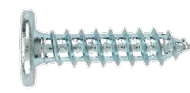

Forged Pancake Type A

Type A, Phillips Pancake Head, Zinc Plated

Stock in the following sizes:

10-12 X 1"
12-11 X 1"



Modified Truss Head DS

#2 Drill Point, Phillips Modified Truss (Round Washer Head), Zinc Plated

Stock in the following sizes:

8 X 1/2" 8 X 1 1/4" 8 X 2 1/2"
8 X 3/4" 8 X 1 5/8" 8 X 3"
8 X 1" 8 X 1 7/8"



Modified Truss Head SP

Sharp Point, Phillips Modified Truss (Round Washer Head), Zinc Plated

Stock in the following sizes:

8 X 1/2" 8 X 1 1/4" 8 X 2 1/2"
8 X 3/4" 8 X 1 5/8" 8 X 3"
8 X 1" 8 X 1 7/8"



Modified Truss Head DS Stainless

#2 Drill Point, Phillips Modified Truss (Round Washer Head), 410 Stainless Steel

Stock in the following sizes:

8 X 1/2" 8 X 1 1/4" 8 X 2 1/2"
8 X 3/4" 8 X 1 5/8" 8 X 3"
8 X 1" 8 X 1 7/8"

LIGHT GAUGE METAL TO WOOD FASTENERS

ITW Buildex



Buildex TruGrip No Washer

Sharp Point, 1/4" HWH, Climaseal Coated

Stock in the following sizes:

9-15 X 1" 9-15 X 2 1/2"
9-15 X 1 1/2" 9-15 X 3"
9-15 X 2"

ITW Buildex



Buildex TruGrip With Washer

Sharp Point, 1/4" HWH, EPDM Washer, Climaseal Coated

Stock in the following sizes:

9-15 X 1" 9-15 X 2 1/2"
9-15 X 1 1/2" 9-15 X 3"
9-15 X 2"

SFS

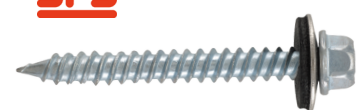

WoodGrip 304SS

Sharp Point, 1/4" HWH, 304SS Head and Shank, Stainless Bonded Washer

Stock in the following sizes:

9-15 X 1" 9-15 X 2 1/2"
9-15 X 1 1/2" 9-15 X 3"
9-15 X 2"



SPECIALTY FASTENERS AND ACCESSORIES



ITW Buildex

Buildex Wood to Metal Self Drillers

TEKS® 3 or 4, PFH, Gray Climaseal Coating

Stock in the following sizes:

- | | |
|----------------------|----------------------|
| 10-16 X 1" Tek 3 | 12-24 X 1 5/8" Tek 4 |
| 10-24 X 1 7/16 Tek 3 | 12-24 X 2 1-4" Tek 4 |
| 10-24 X 1" Tek 3 | 12-24 X 2 3/4" Tek 4 |
| | 1/4-20 X 3 Tek 4 |



Neo Washers

EPDM Bonded Washers, Cor-Guard and SS

Stock in the following sizes:

- | | |
|-------------------|-------------------|
| Cor-Guard | Stainless Steel |
| #6 - #14 Diameter | #6 - #14 Diameter |



#12-16 ACM Screw Facade Attachment

#3 Drill Point, Flat Head, T25W Drive, 300SS Head and Shank, ACM to Aluminum

Stock in the following sizes:

- 12-16 X 7/8"

SELF-TAPPING FASTENERS



ELCO

Tap-Flex® Thread Forming Screws

HWH with Serrations, Stalgard Coating

Stock in the following sizes:

- | | | |
|-----------------|-----------------|-----------------|
| 3/8-16 X 1 1/2" | 1/2-13 X 1 1/2" | 5/8-11 X 1 1/2" |
| 3/8-16 X 2" | 1/2-13 X 2" | 5/8-11 X 2" |
| 3/8-16 X 2 1/2" | 1/2-13 X 2 1/2" | 5/8-11 X 2 1/2" |
| 3/8-16 X 3" | 1/2-13 X 3" | 5/8-11 X 3" |
| 3/8-16 X 4" | 1/2-13 X 4" | 5/8-11 X 4" |
| 3/8-16 X 5" | 1/2-13 X 5" | 5/8-11 X 5" |



ATLAS BUILDING PRODUCTS

Self-Tappers #14 Type A W/Washer

3/8" Hex Head With Sealing Washer

Stock in the following sizes:

- | | |
|--------------------------|-----------------------------|
| 14 X 3/4" Carbon Steel | 14 X 3/4" Stainless Steel |
| 14 x 1" Carbon Steel | 14 x 1" Stainless Steel |
| 14 X 1 1/4" Carbon Steel | 14 X 1 1/4" Stainless Steel |
| 14 X 1 1/2" Carbon Steel | 14 X 1 1/2" Stainless Steel |
| 14 X 2" Carbon Steel | 14 X 2" Stainless Steel |
| 14 X 2 1/2" Carbon Steel | 14 X 2 1/2" Stainless Steel |
| 14 X 3" Carbon Steel | 14 X 3" Stainless Steel |
| 14 X 3 1/2" Carbon Steel | 14 X 3 1/2" Stainless Steel |
| 14 X 4" Carbon Steel | 14 X 4" Stainless Steel |
| 14 X 5" Carbon Steel | 14 X 5" Stainless Steel |
| 14 X 6" Carbon Steel | 14 X 6" Stainless Steel |



ATLAS BUILDING PRODUCTS

Self-Tappers #14 Type A No Washer

3/8" Hex Head

Stock in the following sizes:

- | | |
|--------------------------|-----------------------------|
| 14 X 3/4" Carbon Steel | 14 X 3/4" Stainless Steel |
| 14 x 1" Carbon Steel | 14 x 1" Stainless Steel |
| 14 X 1 1/4" Carbon Steel | 14 X 1 1/4" Stainless Steel |
| 14 X 1 1/2" Carbon Steel | 14 X 1 1/2" Stainless Steel |
| 14 X 2" Carbon Steel | 14 X 2" Stainless Steel |
| 14 X 2 1/2" Carbon Steel | 14 X 2 1/2" Stainless Steel |
| 14 X 3" Carbon Steel | 14 X 3" Stainless Steel |
| 14 X 3 1/2" Carbon Steel | 14 X 3 1/2" Stainless Steel |
| 14 X 4" Carbon Steel | 14 X 4" Stainless Steel |
| 14 X 5" Carbon Steel | 14 X 5" Stainless Steel |
| 14 X 6" Carbon Steel | 14 X 6" Stainless Steel |

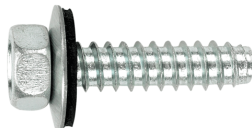

ATLAS BUILDING PRODUCTS

Self-Tappers #14 Type B W/Washer

3/8" Hex Head With Sealing Washer, 300 Stainless Steel

Stock in the following sizes:

- | | |
|-----------------------------|-------------------------|
| 14 X 3/4" Stainless Steel | 14 X 4" Stainless Steel |
| 14 x 1" Stainless Steel | 14 X 5" Stainless Steel |
| 14 X 1 1/4" Stainless Steel | 14 X 6" Stainless Steel |
| 14 X 1 1/2" Stainless Steel | 14 X 7" Stainless Steel |
| 14 X 2" Stainless Steel | 14 X 8" Stainless Steel |
| 14 X 2 1/2" Stainless Steel | |
| 14 X 3" Stainless Steel | |



ATLAS BUILDING PRODUCTS

Self-Tappers #14 Type B No Washer

3/8" Hex Head With Sealing Washer, 300 Stainless Steel

Stock in the following sizes:

- | | |
|-----------------------------|-------------------------|
| 14 X 3/4" Stainless Steel | 14 X 4" Stainless Steel |
| 14 x 1" Stainless Steel | 14 X 5" Stainless Steel |
| 14 X 1 1/4" Stainless Steel | 14 X 6" Stainless Steel |
| 14 X 1 1/2" Stainless Steel | 14 X 7" Stainless Steel |
| 14 X 2" Stainless Steel | 14 X 8" Stainless Steel |
| 14 X 2 1/2" Stainless Steel | |
| 14 X 3" Stainless Steel | |

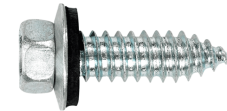

#17 Self-Tappers

Strip-Out Repair, Type AB Thread

Stock in the following sizes:

- | | |
|-----------------------------|------------------------|
| 17 X 3/4" Stainless Steel | 17 X 3/4" Carbon Steel |
| 17 x 1" Stainless Steel | |
| 17 X 1 1/2" Stainless Steel | |



ITW Buildex

#17 SCOTS Replacement Screws

AB Point, HWH, 300 Series Stainless Cap, Integrated Washer, Climaseal Coating

Stock in the following sizes:

- 17-14 X 1"



23/64" ScruBolts (Butler Bolts)

23/64" Diameter Replacement Tappers

Stock in the following sizes:

- | | |
|----------------------------|--------------------------|
| 23/64 X 1" Stainless Steel | 23/64" X 1" Carbon Steel |
|----------------------------|--------------------------|



11/32" ScruBolts (Butler Bolts)

11/32" Diameter Replacement Tappers, AB

Stock in the following sizes:

- | | |
|----------------|-------------------------|
| 11/32 X 7/8" | 11/32" X 7/8" W/Washer |
| 11/32 X 1 1/4" | 11/32 X 1 1/4" W/Washer |
| 11/32 X 1 1/2" | 11/32 X 1 1/2" W/Washer |
| 11/32 X 1 3/4" | 11/32 X 1 3/4" W/Washer |

410 Stainless Parts Available to Order

SEALANTS



POLYURETHANES - SILICONE SEALANTS

SPECIALTY SEALANTS - ADHESIVE SEALANTS

SPECIALTY SEALANTS

FIRE RATED SEALANTS - PRIMERS

POLYURETHANE EXPANSION FOAMS AND ACCESSORIES

TRAFFIC AND DECK COATING

BACKER ROD - FOAM PRODUCTS - TAPE PRODUCTS

CAULK DISPENSING TOOLS AND ACCESSORIES

POLYURETHANE SEALANTS

MASTER®
BUILDERS
SOLUTIONS



MasterSeal NP 1

MasterSeal NP 1 is a one-component, high-performance, non-priming, gun-grade, elastomeric polyurethane sealant. It requires no mixing and typically requires no priming to bond to many materials, including concrete and masonry.

Stock in 10.3 oz. cartridges and 20 oz. sausages

Stock colors: White, Stone, Limestone, Black, Medium Bronze, Aluminum Gray, Tan, Off White, Special Bronze, Redwood Tan, Gray

TREMCO
Commercial Sealants & Waterproofing



Vulkem® 116

Vulkem® 116 is a textured, single-component, moisture-curing, gun-grade polyurethane sealant. Vulkem 116 is an excellent general-purpose sealant designed for use on poured and precast concrete, masonry work, window and door perimeters, and similar types of construction joints.

Stock in 10.3 oz. cartridges and 20 oz. sausages

Stock colors: Almond, Aluminum, Aluminum Stone, Anodized Aluminum, Beige, Black, Bronze, Buff, Dark Bronze, Gray, Ivory, Limestone, Natural Clay, Redwood Tan, Stone, White

TREMCO
Commercial Sealants & Waterproofing



Dymonic® FC

Dymonic® FC is a high-performance, fast-curing, single-component, low-modulus, hybrid sealant, formulated with proprietary silane end-capped polymer technology. Dymonic FC is a durable, flexible, sealant that offers excellent performance in moving joints and exhibits tenacious adhesion once fully cured.

Stock in 10.3 oz. cartridges and 20 oz. sausages

Stock colors: Almond, Anodized Aluminum, Aluminum Stone, Beige, Black, Bronze, Buff, Dark Bronze, Gray, Hartford Green, Ivory, Limestone, Natural Clay, Off White, Precast White, Redwood Tan, Stone and WhiteStone, White

MASTER®
BUILDERS
SOLUTIONS



MasterSeal SL 1

MasterSeal SL-1 (formerly known as Sonolastic SL-1) is a one-component, non-priming, elastomeric, self-leveling polyurethane sealant designed for expansion joints in concrete floors and decks.

Available in quart tubes; 12 per case.

Stock colors: Limestone and Grey

TREMCO
Commercial Sealants & Waterproofing



Vulkem® 45SSL

Vulkem® 45SSL is a semi-self-leveling, single-component, moisture-curing, low-modulus, polyurethane sealant.

Stock in quart tubes

Available in Black, Buff, Gray, Limestone, White

TREMCO
Commercial Sealants & Waterproofing



Dymonic® 100

Dymonic® 100 is a high-performance, high-movement, single-component, medium-modulus, low-VOC, UV-stable, non-sag polyurethane sealant.

Stock in 20 oz. sausages

Stock colors: Almond, Aluminum Stone, Anodized Aluminum, Beige, Black, Bronze, Buff, Dark Bronze, Gray, Gray Stone, Hartford Green, Ivory, Light Bronze, Limestone, Natural Clay, Off White, Precast White, Redwood Tan, Sandalwood, Stone, and White



Tremco Dymeric® 240FC

Dymeric® 240FC is a gun-grade, multi-component, chemically-curing, polyurethane sealant that includes a tintable base, curative packet, and a choice of 70 standard colors.

Sold in 1 1/2 gallon pails

TREMCO
Commercial Sealants & Waterproofing



Tremco Universal Color Packs

These color packs are used for tinting the Dymeric 240FC. 70 standard colors available. 1 pack per 1 1/2 gallon pail.

Sold in individual single use packs

MASTER®
BUILDERS
SOLUTIONS



MasterSeal NP 2

MasterSeal NP 2 (formerly known as Sonolastic NP 2) is a multi-component, highly flexible, non-priming, high-performance polyurethane sealant.

Sold in 1 1/2 gallon pails

MASTER®
BUILDERS
SOLUTIONS



MasterSeal 900 Color Packs

MasterSeal 900 Color Packs are available in 40 standard colors for approved multi-component products, like NP-2.

Sold in individual single use cans

SILICONE SEALANTS



Spectrem® 1

Spectrem® 1 is a high-performance, single-component, moisture-cure, ultra-low modulus silicone sealant.

Stock in 20 oz. sausages and 10.1 oz. cartridges.

Stock colors: Clear, White, Precast White, Ivory, Sandstone, Buff, Off White, Limestone, Anodized Aluminum, Gray, Aluminum Stone, Light Bronze, Champagne, Adobe Tan, Rustic Brick, Hartford Green, Charcoal, Bronze, Dark Bronze, Black



Spectrem® 2

Spectrem® 2 is a high-performance, single-component, neutral-cure, medium-modulus silicone sealant.

Stock in 20 oz. sausages and 10.1 oz. cartridges.

Stock colors: Aluminum Stone, Anodized Aluminum, Black, Bronze, Gray, Limestone, Off White, Precast White, White, Clear and Light Bronze



Spectrem® 3

Spectrem® 3 is a single-component, neutral-cure, low-modulus, construction grade sealant with patented silicone technology.

Stock in 20 oz. sausages and 10.1 oz. cartridges.

Stock colors: Adobe Tan, Aluminum Stone, Anodized Aluminum, Black, Bronze, Buff, Champagne, Charcoal, Dark Bronze, Gray, Hartford Green, Ivory, Light Bronze, Limestone, Off White, Precast White, Rustic Brick, Sandstone, White



Spectrem® 4-TS

Spectrem® 4-TS is a multi-component, low-modulus construction sealant with patented advanced silicone technology. Non-staining and low polar attraction to dirt increases aesthetic appearance. Spectrem 4-TS offers color flexibility with the opportunity to tint the material on site.

Stock in 1 1/2 gallon pails

Stock colors: 70 standard tint packs available



Tremsil® 400

Tremsil® 400 is a high-performance, single-component, neutral-cure, medium-modulus silicone sealant.

Stock in 20 oz. sausages and 10.1 oz. cartridges.

Stock colors: Limestone, White, Anodized Aluminum, Residential Sandalwood, Bronze, Light Bronze, Builders Stone, Geographic Beige, T400 Charcoal, T400 Independence Gray, T400 Medium Gray, T400 Gray, Black, and Off White



DOWSIL™ 756 Building Sealant

A medium-modulus elastomeric sealant designed for weatherproofing sensitive porous stone and metal panel substrates to reduce residue rundown and substrate staining in new and remedial construction.

Stock in 20 oz. sausages

Stock colors: Adobe Tan, Black, Bronze, Grey, Limestone, Precast White, White



DOWSIL™ 790 Silicone Sealant

A one-part silicone formulation that cures in the presence of atmospheric moisture to produce a durable, fire-resistant, flexible and ultra-low-modulus silicone rubber building joint seal.

Available in 10.3 oz. tubes and 20 oz. sausages.

Stock colors: Adobe Tan, Black, Blue Spruce, Bronze, Charcoal Gray, Dusty Rose, Gray, Limestone, Natural Stone, Precast White, Rustic Brick, Sandstone, White



DOWSIL™ 791 Silicone Sealant

A one-part, medium-modulus, elastomeric sealant designed for general weathersealing. It is a silicone formulation that cures to a flexible and curable silicone rubber building joint seal.

Available in 10.3 oz. tubes and 20 oz. sausages.

Stock colors: Black, Gray, Bronze, Limestone, Camel, Precast White, and White



DOWSIL™ 795 Silicone Sealant

A one-part, cold-applied, non-sagging silicone material that cures to a medium modulus silicone rubber upon exposure to atmospheric moisture.

Available in 10.3 oz. tubes and 20 oz. sausages.

Stock colors: Adobe Tan, Anodized Aluminum, Black, Blue Spruce, Bronze, Champagne, Charcoal Gray, Custom, Dusty Rose, Gray, Limestone, Natural Stone, Rustic Brick, Sandstone, White





DOWSIL™ 799 Silicone Glaze and Metal Building Sealant

A clear, fast cure, neutral cure silicone sealant for glazing and weathersealing applications.

Stock in 304 ml cartridges

Color: Clear



DOWSIL™ 999A Silicone Glazing Sealant

An easily applied, one-part sealant that cures in the presence of atmospheric moisture to produce a durable and flexible glazing and curtain wall seal.

Stock in 10.3 oz. cartridges

Stock colors: Aluminum, Black, Bronze, Clear, Light Bronze, White



DOWSIL™ 732 Multi-Purpose Sealant

General-purpose acetoxo RTV sealant. One-part adhesive/sealant. Cures at room temperature when exposed to moisture in the air.

Stock in 10.3 oz. cartridges

Stock colors: Aluminum, Black, Clear, White



DOWSIL™ 786 Silicone Sealant

Designed to seal nonporous surfaces around showers, tubs, sinks and plumbing fixtures where conditions of high humidity and temperature extremes exist.

Stock in 310 ml cartridges

Stock colors: Clear, White



DOWSIL™ CWS

A one-part, moisture cure, medium modulus sealant that provides durable, flexible, watertight joints and offers outstanding unprimed adhesion to most non-porous substrates. It is specifically developed for sealing dynamically moving joints.

Stock in 310 ml cartridges

Available in 20 standard colors and 19 special colors. Customs available.



GE SCS 1000 Contractors Sealant

SCS1000 Contractors 100% silicone is a one-part sealant for sealing and glazing, bedding and grouting tile, sealing counter tops, fixtures, drains, and more.

10.1 fl. oz. cartridges; 24 per case.

Available in Translucent, White, Black, Aluminum

ADHESIVE SEALANTS



Surebond SB-190 EVERSEAL Adhesive Sealant

Versatile, high strength, hard-setting, one-part adhesive sealant. Water and weather-proof. High strength and flexible with excellent memory.

Stock in 10.3 oz. cartridges

Color: Clear



MasterWeld 948 - Polyurethane Adhesive

MasterWeld 948 is a one component, high strength, high solids, polyurethane adhesive. It produces a permanent overnight bond to almost any substrate in a variety of climates.

Stock in quart tubes; 12 per case

Color: Light Brown



MasterSeal NP125 Thermoplastic Adhesive

MasterSeal NP 125 is a one-component, high-performance, non-priming, gun-grade, thermoplastic adhesive and sealant.

Color: Clear, Black, White



Henry® 212 All Purpose Crystal Clear Sealant

Henry® 212 All Purpose Crystal Clear Sealant is a one-part, highly elastic, high-performance thermoplastic sealant.

Stock in 10.1 oz. cartridges

Color: Clear

SPECIALTY SEALANTS

**MASTER®
BUILDERS**
SOLUTIONS



MasterSeal NP 150

MasterSeal NP 150 is a high performance, very low-modulus, high-movement, non-sag, fast-curing, hybrid sealant.

Stock in 10.3 oz. cartridges

Available in the following colors: White, Stone, Limestone, Black, Medium Bronze, Aluminum Gray, Tan, Off-White, Special Bronze, and Precast White

Geocel



Geocel 2300® Tripolymer Sealant

2300® Construction Tripolymer Sealant is a single component, high-performance elastomeric sealant for use in a wide variety of construction applications.

Stock in 10.3 oz. cartridges

Color: Clear

TREMCO
Commercial Sealants & Waterproofing



TremPro® JS-773

TremPro® JS-773 is a high solids, non-skinning, non-drying, synthetic, butyl elastomer sealant.

Stock in quart tubes

CHEMLINK
A COPOLYMER GROUP COMPANY



Chemlink Metalink Metal Roof Sealant

MetaLink is a multi-purpose neutral cure, silicone construction and roof sealant specially formulated for application in a variety of job site conditions. MetaLink is UV resistant. MetaLink is designed for use with many building materials including galvanized aluminum, metal, Kynar 500 PVDF coated metal, glass, and most roofing materials.

Stock in 10.3 oz. cartridges

24+ colors in stock!

BUILDING TRUST
Sika



SikaLastomer®-511 Non-Skinning Butyl

SikaLastomer®-511 is a high solids, non-hardening, butyl rubber-based sealant designed for factory sealing the female lip of standing seam roof and wall panels, and concealed end laps.

Stock in 300 ml cartridges

DP DESIGN POLYMERICS



DP 1010 Water Based Duct Sealant

A premium grade, UL Listed, Low VOC, smooth, water based, high pressure/high velocity duct sealant for commercial and residential supply and return air duct use.

Stocked in 1 gallon pails

FIRE RATED SEALANTS

RECTORSEAL
A COW Industrial Company



Metacaulk® Joint Strip

A flexible, highly intumescent firestop material used in concrete and masonry control floor and wall joints up to 2" (51 mm) wide.

Available in the following sizes (82 Foot Rolls):

| | |
|--------|----------------------------|
| 1" | 2 1/2" |
| 1 1/2" | 3" |
| 2" | 4" (with adhesive backing) |

RECTORSEAL
A COW Industrial Company



Metacaulk 150+

Metacaulk 150+ is a general fire rated sealant for construction joints & through penetrations. Prevents spread of flames/smoke/hot gases/water. All systems rated for up to 4 hours as per ASTM E814 (UL1479) & ASTM E1966 (UL 2079) test standards

Stock in 10.3 oz. tubes

Also available in sausages, quarts, and pails

RECTORSEAL
A COW Industrial Company



Metacaulk 1000

Metacaulk 1000 is a 1-component, general fire-rated sealant/smoke seal for construction joints & through-penetrations. Cures to elastomeric seal suited to dynamic motion.

Stock in 10.3 oz. tubes



PRIMERS

MASTER® BUILDERS SOLUTIONS



MasterSeal P173 Primer

Masterseal P 173 is a quick drying solvent-based primer for priming joints and substrates before application of MasterSeal NP 1, TX 1, NP 2, CR 195, SL 1, SL 2, and NP 150 series sealants.

Stock in 1 pint cans

MASTER® BUILDERS SOLUTIONS



MasterSeal P176 Primer

MasterSeal P 176 is a high-solids, low-VOC solvent-based primer for priming joints and substrates before application of MasterSeal NP 1, TX 1, NP 2, NP 100, CR 100 and CR 195 sealants.

Stock in 1 pint cans

MASTER® BUILDERS SOLUTIONS



MasterProtect P 8100AP

MasterProtect P 8100AP is a one-component zinc-rich epoxy primer. It is designed to prime and protect reinforcing steel. MasterProtect P 8100AP combats corrosion through electrochemical means by preventing anode transfer.

Stock in 1 quart cans

DOW



DOW



DOW



TREMCO
Commercial Sealants & Waterproofing



DOWSIL™ Primer-C OS

Primer for silicone adhesives and sealants offering a low VOC and unique fluorescing feature, allowing for a visual quality control check to ensure primer has been applied.

Stock in 500 mL bottles; 4 per carton

DOWSIL™ Construction Primer P

Primer for silicone adhesives and sealants offering a low VOC and unique fluorescing feature, allowing for a visual quality control check to ensure primer has been applied.

Stock in 500 mL bottles; 4 per carton

DOWSIL™ 1200 OS Primer

An air drying primer supplied as a dilute solution of moisture reactive materials in volatile siloxane and is used to improve both the quality and speed of adhesion development to room temperature vulcanizing silicone sealants to a variety of common non-porous substrates.

Stock in 500 mL bottles; 4 per carton

Vulkem® Primer #171

Vulkem® Primer #171 is a quick-drying, one-part, moisture-curing primer that enhances adhesion to concrete, plywood and other porous substrates where Vulkem® urethane sealants, membranes or coatings will be applied.

Stock in quart cans

POLYURETHANE EXPANSION FOAM AND ACCESSORIES

DEWALT



DEWALT



DEWALT



TREMCO
Commercial Sealants & Waterproofing



TREMCO
Commercial Sealants & Waterproofing



TREMCO
Commercial Sealants & Waterproofing



Triggerfoam™ Pro - Standard

TriggerFoam Pro is a one part polyurethane expanding foam which sets into its final form by using moisture present in the air.

Stock in 29 oz. cans

Triggerfoam Pro 20" Metal Gun

High quality, contractor-grade Triggerfoam dispensing gun.

Sold per each cans

Triggerfoam Pro Cleaner

Used to clean dispensing tools and equipment.

Stock in 17 oz. cans

ExoAir® LEF Low-Expanding Polyurethane Foam

ExoAir® LEF is a single-component, CFC-free, all-season, high performance, gun-grade polyurethane foam that performs as a thermal barrier.

Tremco LEF Foam Gun

Tremco Metal Polyurethane Foam Gun offers rugged construction for a long life.

Tremco Polyurethane Foam Cleaner

Tremco® Polyurethane Foam Cleaner is a multi-purpose cleaning agent used to dissolve uncured or fresh polyurethane foam

Stock in 16 oz. cans; 12 per case

TRAFFIC AND DECK COATING

**MASTER®
BUILDERS**
SOLUTIONS



MasterSeal M200 SLV

MasterSeal M200 is a one-component, moisture curing polyurethane base coat for use in MasterSeal Traffic 1500 and 2000 deck coating systems. Recommended uses include: Stadiums, balconies, parking garages, commercial construction, and plaza decks.

Stock in 5 gallon pails.

**MASTER®
BUILDERS**
SOLUTIONS



MasterSeal® TC 225 Aliphatic Polyurethane Topcoat

MasterSeal TC 225 is a moisture-curing polyurethane top coat for use in MasterSeal Traffic 1500 deck coating systems.

Stock in 5 gallon pails.

Stock colors: Grey, Charcoal, Tan, Dark Bronze, and Tint Base

**MASTER®
BUILDERS**
SOLUTIONS



MasterSeal M350

MasterSeal 350 is a rapid-curing, skid-resistant, epoxy-based concrete overlay system. When mixed with aggregate it can be used as a repair mortar.

Stock in 10 gallon kits (5 gallon part A and 5 gallon part B)

TREMCO™
Commercial Sealants & Waterproofing



Vulkem® 350NF/346/346 Vehicular Coating System

Vulkem® 350NF/346/346 is a modified polyurethane traffic deck coating system composed of a base coat (350NF), heavy duty intermediate coat (346) and a top coat (346).

Stock in 5 gallon pails

Colors: Gray, Limestone and Slate Gray. Made-to-order and special colors also are available upon request.

TREMCO™
Commercial Sealants & Waterproofing



Vulkem® 350NF/951NF Pedestrian Coating System

Pedestrian Coating System - Low Odor/Fast Cure. Vulkem® 350NF/951NF is a composite waterproofing system comprised of tough-curing liquid polyurethane. It cures to form a rubber membrane surface that provides a lasting and easy-to-clean coating.

Stock: Vulkem 350NF (5 gallon pails) and Vulkem 951NF (5 gallon pails)

Colors: Black, Slate Gray, Gray, White, Limestone, Beige, Maple, Charcoal



Vulkem® 360NF/950NF/950NF Vehicular Coating System

Vulkem® 360NF/950NF/950NF is a modified polyurethane traffic deck coating system composed of a base coat (360NF), heavy duty intermediate coat (950NF) and a top coat (950NF).

Stock: Vulkem 360NF (5 gallon drums) and Vulkem 950NF (4.2 gallon kit)

Colors: Gray, Slate Gray, and Black. Made-to-order and special colors also are available upon request.



Vulkem® OC810 Light Pedestrian Coating System

One-Coat, Low-Odor, Low-VOC Deck Coating for Light Pedestrian Applications. Vulkem® OC810 Coating is a high-solids, aliphatic urethane membrane designed to be applied in one coat as a waterproofing system.

Stock in 5 gallon drums

Colors: Gray, Beige, Maple, Slate Gray, and Limestone. Special colors are available upon request.

TREMCO™
Commercial Sealants & Waterproofing

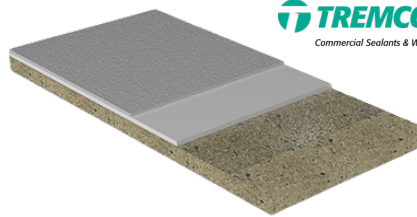

Vulkem® 350/351 Pedestrian Coating System

Vulkem® 350/351 is a composite waterproofing system comprised of toughcuring liquid polyurethane. It cures to form a rubber membrane surface that provides a lasting and easy-to-clean coating.

Stock: Vulkem 350 (5 gallon pails) and Vulkem 351 (5 gallon pails)

Colors: Beige, Gray, Limestone, Maple, Slate Gray, Black, and White. Special colors are available upon request.

TREMCO™
Commercial Sealants & Waterproofing



TREMprime™ Non-Porous Primer

TREMprime™ Non-Porous Primer is a low-VOC, water-based, quick-drying, one-part primer used as an adhesion promoter for urethane sealants and coatings on non-porous surfaces such as metals and plastics.

Stock: 1 quart cans or 1 gallon pails



BACKER ROD, FOAM PRODUCTS, TAPE PRODUCTS



Closed Cell Backer Rod

Closed cell backer rod is a closed cell polyethylene foam that is round and flexible. Backer Rod is used to partially fill deep expansion joints and cracks before application of your sealant.

Stock sizes: 1/4", 3/8", 1/2", 5/8", 3/4", 1", 1 1/4", 1 1/2", 2", 3"



Open Cell Backer Rod

Round, flexible, continuous lengths of open-cell polyurethane foam backer rod for use as a backing material for elastomeric and other cold applied sealants.

Stock sizes: 3/8", 5/8", 7/8", 1 1/8", 1 1/2", 2", 2 1/2", 3", 4"



Denver Foam

Denver Foam® is an open cell polyurethane backer rod serving as a backing for elastomeric and other applied caulking sealants.

Stock sizes: 5/8", 7/8", 1 1/8", 1 1/2", 2"



Tundra Foam

Tundra Foam is an ideal non-gassing backup material that is inserted into construction and pavement joints to control sealant depth.

Stock sizes: 3/8", 5/8", 7/8", 1 1/8", 1 1/2", 2"



Butyl Tape Caulk

Multi-purpose butyl tape is a high performance, tacky elastic butyl tape which is designed to bond through oily GALVALUME, KYNAR 500, aluminized steel, ZINCALUME, galvanized metal, aluminum, siliconized polyester and polyvinyl fluoride painted metals, glass, wood, concrete, fiber-reinforced plastics (FRP) and similar substrates.

Stock sizes include: 3/32" X 1", 3/16" X 7/8" Double Bead, 1/8" X 1 5/8", 3/8" X 3/32", 1/2" X 3/32", 1/2" X 1/8", 1" X 1/8"



3M All Weather Flashing Tape 8067

3M™ All Weather Flashing Tape 8067 is a self-adhered, waterproof flashing membrane designed for sealing around openings and penetrations in exterior walls. This product has a unique acrylic pressure sensitive adhesive that aggressively sticks and stays stuck both at lower and higher application temperatures than traditional flashing tapes. It even adheres to damp surfaces.

Stock sizes include: 4" X 75', 6" X 75', 9" X 75'



Bond Breaker Tape

Tape that provides a unique way to break the bond of sealant between the cement joints. The tape does not allow the sealant to adhere to the tape backing allowing the sealant joint to only adhere to the two cement sides.

Stock sizes: 1/4" X 100' Clear or Black, 3/8" X 100' Clear or Black, 1/2" X 100' Clear or Black, 3/4" X 100' Clear or Black, 1" X 100' Clear or Black, 2" X 100' Clear or Black, 3" X 100' Black, 4" X 100' Black



Tremco® 440 Tape

Tremco® 440 Tape is a 100% solid Polyisobutylene cross-linked butyl, preformed sealant.

Stock sizes include: 1/16" X 1/2" X 50', 1/4" X 1/2" X 20', 1/8" X 1/2" X 25'

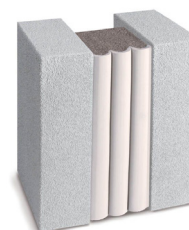

EMSEAL Expansion Joints and Pre-Compressed Sealants

Expansion joints and sealants for buildings. Waterproof, fire rated, trafficable, sound attenuating, insulating, air, wind, seismic, and watertight, building expansion joints and precompressed hybrid sealants. A Sika Company.

Dozens of styles, sizes, and colors available. Contact your PRO rep for more info.

CAULK DISPENSING TOOLS AND ACCESSORIES



Albion 139-3 1/10 Gallon Manual Cartridge Gun w/ Plated Metal Carriage

5/16" thick square rod that you can rotate 4 times for longer life. Quality zinc chromate plating to prevent rust.



Albion B-1 1/10th Gallon B-Line Manual Skeleton Cartridge Gun w/ 7:1 Drive

Lightweight tool with smooth action and comfortable trigger. Stores flat in tool box.



Albion B12 1/10 Gallon B-Line Manual Cartridge Gun w/ 12:1 Drive

1/10th Gal Smooth Rod Cartridge Gun with 12:1 mechanical advantage drive.



Albion B-12S20 B-Line Manual Sausage Caulking Gun, 20 oz., 12:1 Drive

12:1 manual drive 20 oz. sausage adhesive caulking gun, with 2" diameter aluminum barrel. Thrust: 375 lbf, Pressure: 120 psi



Albion B26Q 1 Quart B-Line Manual Cartridge Gun w/ High-Thrust 26:1 Drive

26:1 manual drive cartridge adhesive caulking gun for use on 1 quart or 750 ml cartridges. Highest Thrust: 900 lbf, Pressure: 170 psi



Albion DL-45-02 20 oz. Deluxe Manual Sausage Gun

2" steel barrel, Teflon piston, 120 psi and 375 lbf.



COX 51001 Avon 600 20-Ounce Sausage/10.3-Ounce Cartridge Bulk Applicator

Mechanical advantage 12:1. Plunger Extension - reduces waste; Plungers included for cartridge and bulk (G2) applications.



Newborn 111CB 1/10GL 1/10 Gallon Superior E-Z Thrust Hex Rod Caulking Gun

10:1 thrust ratio. Features seal puncture tool, spout cutter, ladder hook, EZ load front cap, and includes a Caulk Buddy!



Albion 235-3 Orange Nose Cones

For 2" diameter bulk or sausage guns.



Albion 935-4 Bent Cone Nozzle

45° bent nozzle for hard to reach areas.



COX Black Nose Cone

Plastic clip-on nozzle for COX dispensing tools.



Newborn PC-620 Yellow Plastic Cone

Yellow Plastic Cone to be used with sausage guns



Caulk (Pipe) Knives

Used to cut old caulk from joints prior to recaulking. All steel construction means durability on rough surfaces.

816-G01 12" | 816-G02 18" | 816-G03 24"



Replacement Blades

Replacement blades available to keep your Pipe Knife in top shape.

Serrated and straight edge available



Albion Mixing Paddle

Mixing paddle for 5 gallon pails. Fits 1/4" drill chuck. 18" shaft,



Shims

Used to cut old caulk from joints prior to recaulking. All steel construction means durability on rough surfaces.

816-G01 12" | 816-G02 18" | 816-G03 24"

CAULKING ACCESSORIES



Albion Spatulas

Classic hardwood handle.
 258-3TPS 3/8" Tapered
 258-3S 5/8"
 258-4TPS 7/16" Tapered
 258-4S 3/4"
 258-5TPS 1/2" Tapered
 258-5S 7/8"
 258-6S 1"
 258-8S 1 1/4"
 258-10S 1 1/2"

Albion 958-G01 Streamline Caulk Spatula Set

7-piece set. Comfortable curved handles. Use to create proper concave joint profile & ensure good adhesion to substrates.

Marshalltown Tuckpointer Trowels

Tapered for sturdiness and correct flexibility, MARSHALLTOWN's Tuck Pointers are made to create high shank and lift to give plenty of hand room.

Stock in the following: 6 3/4" long, widths of 5/16", 3/8", 1/2", 5/8", 3/4", 7/8", 1"

Chip Brushes

Quality chip brushes in all the standard size.

1/2" thru 4"



Rags and Sweatshirts

Stock styles include:

- 5 Pound Box of Rags
- 10 Pound Box of Rags
- 10 Pounds Reclaimed White Sweatshirt Rags
- 10 Pounds White Cotton Sheet Rags

Caulk Warmer Bag

Large electric warming bag for tubes and sausages of sealant and epoxy. Holds up to 12 tubes (10 oz.).

Caulk Warmer Junior

Electric warming wrap. Also available in 1 and 2 gallon sizes.

Caulk Warmer for 5 Gallon Pail

Versatile electric heater. Red 13" High x 9" Wide x 2.5" Deep 120 VAC - 15 Watts Maximum Temp: 105°F ±

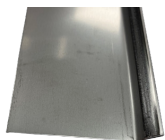

Drip Edge

Stock sizes:

- 1 5/8" X 26 Gauge Stainless Steel
- 3 1/8 X 26 Gauge Stainless Steel
- 3 5/8" X 26 Gauge Stainless Steel

Flat Term Bar

6063-T6 Extruded Aluminum

.090 thick x 1" wide x 10' long per piece.

1/4" x 3/8" slotted holes on 6" centers.

50 pieces per tube

500' per tube

Caulk Edge Term Bar

6063-T6 Extruded Aluminum

.100 thick x 1" wide x 10' long per piece.

1/4" x 3/8" slotted holes on 6" centers.

50 pieces per tube

500' per tube

Stainless Term Bar

Stainless Steel

Stainless steel term bar is available in both flat, caulk edge, and double caulk edge.

Not all branches stock stainless term bar - call your PRO rep for availability,

COMMERCIAL ROOFING



INSULATION ADHESIVES

ROOFING FASTENERS

INSULATION AND MEMBRANE PLATES

SPECIALTY ROOFING FASTENERS

TERMINATION BAR

PITCH POCKETS, DRAINS, DEKTITE, PIPE SUPPORTS

ROOF REPAIR TAPES

ROOF REPAIR PRODUCTS AND SEALANTS

APOC ROOF CEMENT, MASTICS, AND ALUMINUM

ROOFING TOOLS



INSULATION ADHESIVES



OlyBond® 500 Bag-In-Box

OlyBond 500 Insulation Adhesive is a fast-acting, two-component, low-rise polyurethane foam adhesive designed to secure insulation to roof decks. OlyBond 500 can be used in both new and re-roofing applications.

Sold as a set Part 1 & 2 (10 gallons total)



OlyBond® 500 15 Gallon Drums

For larger jobs, OlyBond 500 Insulation Adhesive is available in 15 gallon drums. A modified Pace Cart 3 allows for use of the 15 gallon drums.

Sold as a set Part 1 & 2 (30 gallons total)



OlyBond® 500 Cartridges

SpotShot Cartridges offer a convenient and consistent way to dispense OlyBond 500. Also available in winter grade, with performance down to 0 F.

1500 ml. Cartridges | 4 per box



OlyBond 500 Canisters

OlyBond 500 Insulation Adhesive in a convenient, pressurized canister system (Part 1 and Part 2). Self-contained units require no extra applicator equipment.

Stock in 2 part canister sets



OlyBond 500 Classic

OlyBond Classic is available in large capacity 15 gallon or 50 gallon drum sets and is designed to be applied with a high pressure spray rig on larger, production jobs.

Ships direct on an order by order basis



Millennium One Step Foamable Adhesive®

Millennium One-Step features true all-temperature performance, the ability to set insulation immediately without waiting for foam to rise, a consistently fast lock-down time, and a high-body formula that makes application over rough surfaces easy.

Stock in: 1500 ml cartridges (4 per case)



Millennium PG-1 Pump Grade Adhesive 5 Gallon

Used for bonding roof insulations to a building's structural deck, base sheets, insulation boards, and built-up roof surfaces. Minimizes penetrations, roof deck corrosion, and thermal bridging. Approved for use in VOC regulated markets. Odorless and solvent-free.

Stock in: 5 gallon per box (10 gallon set)



Millennium PG-1 Pump Grade Adhesive 15 Gallon

Used for bonding roof insulations to a building's structural deck, base sheets, insulation boards, and built-up roof surfaces. Minimizes penetrations, roof deck corrosion, and thermal bridging. Approved for use in VOC regulated markets. Odorless and solvent-free.

Stock in: 15 gallon part 1 and 15 gallon part 2



Millennium PG-1 Pump Grade Adhesive Drums

Used for bonding roof insulations to a building's structural deck, base sheets, insulation boards, and built-up roof surfaces. Minimizes penetrations, roof deck corrosion, and thermal bridging. Approved for use in VOC regulated markets. Odorless and solvent-free.

50 gallon drums available to order

INSULATION ADHESIVES CONTINUED

TRUFAST**TruFast Roofing Adhesive Cartridges**

TruFast Roofing Adhesive is a construction-grade, polyurethane foam adhesives designed to adhere to approved roof insulations, thermal barriers, cover boards and fleece backed membranes to acceptable substrates.

Stock in: 1500 ml cartridges (4 per case)

TRUFAST**TruFast Roofing Adhesive Pressurized Tanks**

Clean, fast one-step application resulting in significant labor savings for the contractor. One formula for insulation and fleece-back membrane attachment. Self-contained kit comes with everything needed to apply adhesive.

Sold as set (Part A and Part B)

TRUFAST**TruFast Roofing Adhesive Drums**

Used for bonding roof insulations to a building's structural deck, base sheets, insulation boards, and built-up roof surfaces. Minimizes penetrations, roof deck corrosion, and thermal bridging. Approved for use in VOC regulated markets. Odorless and solvent-free.

Stock in: 5 gallon sets (10 gallons total) and 15 gallon sets (30 gallons total)

H.B. Fuller**Millennium One Step Night Seal**

Millennium OneStep™ Night Seal® is designed for use as a quick and reliable sealer at temporary tie-in locations between new roof covers and existing roof systems. Millennium OneStep™ Night Seal® eliminates the need for messy asphalt mastics and bitumens or less reliable porous surface foams.

Stock in: 1500 ml cartridges (4 per case)

**Froth-Pak Foam Insulation**
Two-component, quick-cure polyurethane foam

Froth-Pak™ comes as a professional sealant for air sealing gaps and penetrations up to 4 inches wide or as a spray foam insulation to fill larger cavities providing both insulation and air sealing properties.

Stock in: Self contained individual units

Versi-Foam systems**Versi-Foam System 15**

Closed cell spray foam insulation kits
Packaged in one carton and includes the two chemical components, Versi-Foam's patented U-Control dispensing gun attached to two 10 foot hoses, ten mixing nozzles, three fan tips, and nitrile gloves. System 15 will produce 198 square feet of cured foam at a 1" thickness, or 16.5 cubic feet.

Stock in: Self contained individual units

Versi-Foam systems**Versi-Foam System 50**

Closed cell spray foam insulation kits
Packaged in two cartons. The system is complete with the two chemical components, our patented U-Control dispensing gun attached to two 15 foot hoses, ten mixing nozzles, three fan tips, and nitrile gloves. Will produce 600 square feet of cured foam at a 1" thickness, or 50 cubic feet.

Stock in: Sold as a set (Part A and B)

**ROOFING ADHESIVE
APPROXIMATE COVERAGE
RATES**

CARTRIDGES: 5 SQUARES PER BOX

BAG-IN-BOX: 25 SQUARES PER SET

CANNISTERS: 35 SQUARES PER SET

15 GALLON DRUMS: 75 SQUARES PER SET

55 GALLON DRUMS: 250 SQUARES PER SET

*APPROXIMATE VALUES ONLY. PLEASE REFER TO THE MANUFACTURER FOR PRODUCT SPECIFIC INFORMATION

**BASED ON SMOOTH SURFACE TO SMOOTH SURFACE ATTACHMENT

**NEED DISPENSING TOOLS?**

CHECK OUT THE ROOFING TOOLS SECTION AHEAD ON PAGE 34! OR CONTACT YOUR PFS REP FOR HELP SELECTING THE RIGHT TOOL.

ROOFING FASTENERS



OMG #12 Standard Roofgrip Drill Point Fastener

The OMG Standard Roofing Fastener (#12), with deep buttress thread for high pullout resistance, is designed to secure insulation to standard steel (18 ga. - 24 ga.) and wood.

Stock in: 1 5/8", 2 1/4", 3", 4", 5", 6", 7", 8"



TruFast #12 Drill Point Roofing Fasteners

The #12 DP Roofing Fasteners are specifically engineered to secure insulation, coverboards, and base sheets to corrugated steel (16-22 gauge) and wood substrates. Featuring a #2 double flute self-drilling point and exclusive tapered entry thread design, they penetrate steel quickly and offer exceptional back-out resistance.

Stock in: 1 5/8", 2 1/4", 2 7/8", 3 1/4", 3 3/4", 4 1/2", 5", 6", 7", 8"



OMG #14 Heavy Duty Roofing Fasteners

OMG Heavy Duty Roofing Fasteners (#14) are designed to secure insulation to steel (18 to 22 Ga.), wood and structural concrete decks. They can also be used to secure membrane to wood and concrete decks. Available in lengths from 1 1/4-in. - 24-in. Factory Mutual and Dade County approved.

Stock in: 1 1/4", 1 3/4", 2", 3", 4", 5", 6", 7", 8", 9", 10", 11", 12", 14", 16", 18", 20", 21", 22", 24"



TruFast #14 HD Roofing Fasteners

TRUFAST® #14 HD Fastener is engineered to secure insulation, coverboards, base sheets and single-ply roof membrane systems to corrugated steel (16 - 22 ga.), wood, and concrete substrates. Featuring a #2 double flute self-drilling point and exclusive tapered entry thread design, they penetrate steel quickly and offer exceptional back-out resistance.

Stock in: 1 1/2", 2", 2 1/2", 3", 3 1/2", 4", 4 1/2", 5", 5 1/2", 6", 7", 8", 9", 10", 11", 12"



TruFast #14 HD Bi-Metal Stainless Steel Roofing Fastener

The #14 HD Stainless Steel Bi-Metal Roofing Fastener is made of 316 austenitic stainless steel alloy with a hardened carbon steel drill point. This all purpose roofing fastener is engineered to secure insulation, coverboards, base sheets and single-ply roof membrane systems to corrugated steel (18-24 ga.) and wood substrates.

Stock in: 1 1/2", 2", 3", 4", 5", 6", 7", 8", 10", 12"



OMG #15 XHD (Extra Heavy Duty) Fastener

OMG Extra Heavy Duty Roofing Fastener (#15) is a high-performance fastener with deep buttress threads for maximum pullout resistance. XHDs are designed to secure insulation and membrane to steel (20 and 22 Ga.), wood, OSB wood plank, and aluminum roof decks.

Stock in: 2", 3", 4", 5", 6", 7", 8", 9", 10", 11", 12", 14", 16"



TruFast #15 EHD Roofing Fasteners

The #15 EHD Fastener is engineered for lap attachment to corrugated steel (18 - 22 ga.) and wood substrates in higher wind uplift roof assemblies.

Stock in: 1 1/4", 2", 3", 4", 5", 6", 7", 8", 9", 10", 11", 12", 14", 16", 18", 20", 22", 24"



OMG RetroDriller Fastener

The OMG RetroDriller Fastener with drill point is designed for attaching single-ply membrane systems to structural steel purlins (up to 3/16-in.) in standing seam metal roof retrofit applications. RetroDriller Fasteners are available in six lengths from 4-in. to 10-in.

Stock in: 4", 5", 6", 7", 8", 10"



TruFast #12 Purlin Roofing Fastener

The #12 Purlin Fastener is a self-drilling fastener engineered to secure single-ply roofing membrane to structural steel purlins (16 ga. to 3/16") in standing seam metal roof recover applications.

Stock in: 1 3/8", 2 3/4", 3 3/4", 4 3/4", 5 3/4", 6 3/4", 7 3/4", 8 3/4", 9 3/4"

ROOFING FASTENERS CONTINUED



OMG ASAP

The OMG ASAP 3S (Assembled Screw And Plate) is designed to secure insulation to steel and wood substrates. The OMG ASAP 3S is an OMG Standard RoofGrip® Fastener (#12) assembled with an OMG 3-in. (75 mm) Galvalume® plate.

Available in: 1 5/8", 2 1/4", 3", 4", 5", 6", 7", 8"



PFS has limited stock of pre-assembled roofing fasteners on the shelf. Please allow extra time for pre-assembled orders to ship.

Also, depending on the PFS location, we offer systems fasteners from major roofing manufacturers like Firestone, JM, GAF, and more!



TruFast #12 DP Pre-Assembled

TRUFAST Pre-assembled fasteners and plates feature a #12 drill point fastener with a 3" Galvalume™ plate and are available in #3 Phillips Truss Head (PA) and 1/4" Hex Head (PAH) styles.

Available in: 1 5/8", 2 1/4", 2 7/8", 3 1/4", 3 3/4", 4 1/2", 5", 6", 7", 8"

INSULATION AND MEMBRANE PLATES



OMG 3" Ribbed Galvalume Plate

OMG Steel Plates are made of Galvalume® coated steel. The round design provides an even distribution of loads and eliminates sharp corners that can damage the insulation or membrane.

Stock in: 1000 count boxes



OMG 3" Galvalume Plate Flat

OMG 3" Flat Bottom Steel Plate used to attach insulation to the substrate. Use with OMG Standard, Heavy Duty, XHD or CD-10 fastener.

Stock in: 1000 count boxes



OMG 2" Metal Seam Plate

Used for attaching single-ply membrane to the substrate. Use with OMG Standard, Heavy Duty or CD-10 fasteners

Stock in: 1000 count boxes



OMG 3" Locking Plastic Plate

OMG Plastic Plates are Factory Mutual and Dade County approved. 3" plates are for attaching insulation to the substrate.

Stock in: 1000 count boxes



OMG 3" AccuTrac Plates

OMG AccuTrac® Insulation Plates are made of Galvalume® coated steel and designed exclusively for use with the stand-up AccuTrac and AccuTrac EZ installation tools.

Stock in: 1000 count buckets



OMG 2 3/8" AccuSeam Plates

Used for attaching single-ply membrane to the substrate. Use with AccuSeam installation tools.

Stock in: 1000 count buckets



TRUFast

TruFast 3" Metal Insulation Plate

TRUFast Metal Insulation Plates are made of Galvalume coated steel for excellent corrosion protection. Plate has a flat bottom and is used to attach roof coverboards, insulation, and BUR base sheets to the substrate.

Stock in: 1000 count buckets



TRUFast

TruFast 2" Metal Seam Plate

TRUFast 2" Metal Seam Plate is used within fully bonded seams to attach reinforced and non-reinforced single-ply membranes to the substrate. Use with TRUFast #14HD, #14 Stainless Steel HD, #15EHD, Purlin, Fluted Concrete Nail or 1/4" Concrete Spike fasteners.

Stock in: 1000 count buckets



TRUFast

TruFast 2.4" Barbed Metal Seam Plate

TRUFast 2.4" Metal Seam Plates are used to attach reinforced single-ply and modified bituminous membranes to the substrate. Use with TruFast #14HD, #14 Stainless Steel HD, #15EHD, Purlin, Fluted Concrete Nail or 1/4" Concrete Spike fasteners.

Stock in: 1000 count buckets

TRUFast



TruFast 2" Barbed Seam Plate

TRUFast 2" Barbed Metal Seam Plate is used to attach reinforced singly-ply and modified bituminous membranes to the substrate. Use with TruFast #14HD, #14 Stainless Steel HD, #15 EHD, Purlin, Fluted Concrete Nail or 1/4" Concrete Spike fasteners.

Stock in: 1000 count buckets

OMG
ROOFING PRODUCTS



OMG RhinoBond Plates

Pro Fastening Systems stocks RhinoBond plates for various roofing systems manufacturers, like JM, GAF, and Firestone. Check with your PFS branch to see which systems brands are available.

Stock in: 500 count buckets

Available in TPO or PVC

OMG
ROOFING PRODUCTS



OMG X-Wing™ Toggle

The OMG X-Wing is a toggle fastener for attaching insulation to a variety of decks including gypsum, cementitious wood fiber, and lightweight insulating concrete decks.

The X-Wing is designed specifically for use with an OMG Extra Heavy Duty (XHD) fastener and a standard 3-in. (75 mm) insulation plate, both sold separately.

Stock in: 1000 count buckets

PRO FASTENING SYSTEMS IS PROUD TO BE A MEMBER OF MANY LOCAL AND STATE ROOFING TRADE ORGANIZATIONS.

WE ARE HAPPY TO GIVE BACK TO THE ROOFING INDUSTRY WHENEVER POSSIBLE.

DID YOU KNOW WE OFFER TOOL DEMOS AND TRAINING, FASTENER AND ADHESIVE TRAINING, PULL TESTS, AND MORE!

LET US KNOW WHAT WE CAN DO TO HELP !

SPECIALTY ROOFING FASTENERS



OMG CD-10 Concrete Fastener

The OMG CD-10 is a hammer-in, non-threaded fastener with a split bulb design that exerts pressure on hole walls for superior strength and hold power. Available in lengths between 2-in and 12-in.

Available in: 2", 2 1/2", 3", 3 1/2", 4", 4 1/2", 5", 5 1/2", 6", 7", 8", 9", 10", 11", 12"



TruFast 1/4" Concrete Spike

The Concrete Spike Fastener is a one-piece, vibration-resistant anchor designed to fasten insulation, single-ply roof membrane, wood, and steel to structural concrete roof decks.

Available in: 1 1/4", 1 1/2", 2", 2 1/2", 3", 3 1/2", 4", 4 1/2", 5", 5 1/2", 6", 6 1/2", 7", 7 1/2", 8", 9", 10", 11", 12", 13", 14", 15", 16"



OMG Lite-Deck Fastener

The OMG Lite-Deck Fastener is designed to secure insulation to gypsum, cementitious wood fiber decks (Perma-deck, Insulrock, Tectum®, etc.) and lightweight structural concrete*. Lite Deck Plates to be used.

Available in: 2 5/8", 3", 4", 5", 6", 7", 8", 9", 10", 12"

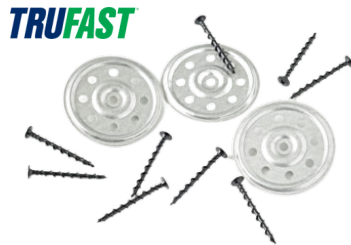

TruFast Versa-Fast® Fasteners

Versa-Fast fasteners are engineered to secure insulation, coverboard and base sheets to light weight insulating concrete and gypsum decks. The Versa-Fast Fastener features an exclusive thread design engineered for exceptional pull out resistance. When used in conjunction with the VERSA-FAST® Metal Plate, multiple fasteners can be installed to achieve the required minimum pull out.

Available in: 2 1/4", 3 1/4", 4 1/4", 5 1/4", 6 1/4"

Versa-Fast Metal Plates - 1000 per box



OMG Polymer GypTec

The OMG Polymer GypTec™ is a high-strength, glass-filled nylon auger fastener with a 1-in. head designed to secure insulation and single-ply membrane to gypsum and cementitious wood fiber.

Available in: 2 1/2", 3", 3 1/2", 4", 4 1/2", 5", 5 1/2", 6", 6 1/2", 7", 7 1/2", 8", 8 1/2", 9", 9 1/2", 10", 10 1/2", 11", 11 1/2", 12"

3" GypTec Metal Plate - 1000 per box

2" GypTec Metal Seam Plate - 1000 per box



TruFast TL Fasteners

TL Fastener is designed to mechanically attach rigid insulation board and single-ply membrane to structural cement wood fiber, gypsum and lightweight insulating concrete roof decks.

Available in: 2", 2 1/2", 3", 3 1/2", 4", 4 1/2", 5", 5 1/2", 6", 6 1/2", 7", 7 1/2", 8", 8 1/2", 9", 9 1/2", 10", 11", 12", 13", 14"

3" TL Metal Plate - 1000 per box

2" TL Metal Seam Plate - 1000 per box



OMG CR Base Sheet Fastener

OMG CR Base Sheet Fasteners are one-piece, precision formed from G-90 galvanized steel, coated with CR-10, and pre-assembled with a 2.75-in. diameter galvalume plate. These fasteners can be used to secure base sheets to poured lightweight insulating concrete, and on certain poured gypsum decks.

Available in: 1.2" (1000/box) and 1.75" (500/box)



OMG Locking Impact Nail

The OlyLok locking impact nail is designed to attach base-ply, recovery board and insulation to wood fiber/poured gypsum decks. It is available in 2 sizes: 1.4-in. and 1.8-in., and is Factory Mutual and Dade County approved.

Available in: 1.4" (500/box) and 1.8" (500/box)



TruFast FM-90 Base Sheet Fastener

For Base Sheet attachment to lightweight insulating concrete and various gypsum roof decks

Stock in: 1000 count boxes



TRUFAST



TRUFAST



TruFast FM-75 Base Sheet Fasteners

For Base Sheet Attachment to higher density lightweight insulating concrete, NVS concrete and various gypsum roof decks.

Stock in : 1000 count boxes

TruFast Twin Loc-Nail Base Sheet Fasteners

For base sheet, recovery board, and insulation attachment to lightweight insulating concrete, structural wood fiber, and poured gypsum. Formed from coated steel to prevent corrosion, the Twin Loc-Nail easily penetrates decking and existing membranes.

Available in: 1.4", 1.8", 2.8", 3.8", 4.8", 1.4" without plate, and 1.8" without plate

OMG Headlok Fasteners

Specialized, flat head fastener engineered for a wide range of panel applications including Structural Insulated Panels, Pre-fabricated Wall Panels, and Nailboard, and can be used in wood, structural concrete,* corrugated and structural steel substrates. Available in three point styles available for fast installation into wood, corrugated steel, and structural steel substrates.



TRUFAST



TRUFAST



TRUFAST

TruFast SIP LD Fasteners

For Light Duty corrugated steel deck and wood applications. Featuring a large, pancake head style with a 6-lobe drive, TRUFAST SIP Fasteners drive quickly and smoothly, and draw panels securely without the need of a washer.

Available in: 3", 3 1/2", 4", 4 1/2", 5", 5 1/2", 6", 6 1/2", 7", 7 1/2", 8", 8 1/2", 9", 9 1/2", 10", 11", 12", 13", 14", 15", 16", 18"

TruFast SIP HD Fasteners

For Heavy Duty thick steel applications. Featuring a large, pancake head style with a 6-lobe drive, TRUFAST SIP Fasteners drive quickly and smoothly, and draw panels securely without the need of a washer.

Available in: 4 1/2", 6", 8", 9 3/4", 11 3/4", 13 3/4"

TruFast SIP TP Fasteners

For Wood and Timber Application. Featuring a large, pancake head style with a 6-lobe drive, TRUFAST SIP Fasteners drive quickly and smoothly, and draw panels securely without the need of a washer.

Available in: 2", 2 1/2", 3", 3 1/2", 4", 4 1/2", 5", 5 1/2", 6", 6 1/2", 7", 7 1/2", 8", 8 1/2", 9", 10", 11", 12", 13", 14", 15", 16"

TERMINATION BAR



Caulk Edge Term Bar

6063-T6 Extruded Aluminum

.100 thick x 1" wide x 10' long per piece.

1/4" x 3/8" slotted holes on 6" centers.

50 pieces per tube

500' per tube



Flat Term Bar

6063-T6 Extruded Aluminum

.090 thick x 1" wide x 10' long per piece.

1/4" x 3/8" slotted holes on 6" centers.

50 pieces per tube

500' per tube



Flat Term Bar .125"

6063-T6 Extruded Aluminum

.125 thick x 1" wide x 10' long per piece.

1/4" x 3/8" slotted holes on 6" centers.

50 pieces per tube

500' per tube



Stainless Steel Term Bar

Stainless Steel

Stainless steel term bar is available in both flat, caulk edge, and double caulk edge.

Not all branches stock stainless term bar - call your PRO rep for availability,

PITCH POCKETS, DRAINS, DEKTITE, AND PIPE SUPPORTS



Millennium Lockin' Pockets®

The patented Millennium Lockin' Pocket® is designed to seal technically challenging roof penetrations where field flashing may not be practical.

Available in: Square Pocket Kits (4", 6", 8"), Octagonal Pocket Kits (3", 5", 8"), U-Build Kits (6", 10", 12") and Straights, Inside and Outside 90's, and Filler



ChemLink 1-Part Pourable Penetration Sealant

1-Part is a moisture curing, pourable sealant designed for use in pitch pans and warranted ChemCurb/E-Curb penetration seals.

Stock in: 2 Liter Pouch / 4 per case Color: White or Black



Dektite Original

The original watertight flashing from metal roofs.

Stock in the following sizes:

| DF100 | DF101 | DF102 | DF103 | DF104 | Pipe Range | Pipe Range | Pipe Range | Pipe Range | Pipe Range |
|-------|-------|-------|-------|-------|---------------|------------|--------------|------------|------------|
| | | | | | 0 - .375" | DF105 | 4.25" - 7.5" | | |
| | | | | | .25" - 2.5" | DF106 | 5" - 9" | | |
| | | | | | 1.75" - 3.25" | DF107 | 6" - 11" | | |
| | | | | | .25" - 5" | DF108 | 7" - 13" | | |
| | | | | | 3" - 6.25" | DF109 | 10" - 19" | | |

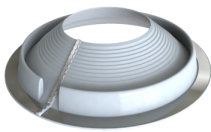

Dektite Retrofit Original

For repairs & difficult to access pipes.

Stock in the following sizes:

| RF801 | RF802 | RF803 | Pipe Range |
|-------|-------|-------|--------------|
| | | | .75" - 2.75" |
| | | | 2" - 7.25" |
| | | | 3.25" - 10" |



Dektite Silicone

High temperature silicone pipe boots.

Stock in the following sizes:

Silicone sizes match the Dektite Original sizes. Just specify Silicone when ordering.

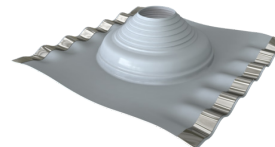

Dektite Soaker - Diverter

For hi/low roof pitches.

Stock in the following sizes:

| DF602 | DF603 | DF605 | DF606 | RFS4 | Pipe Range |
|-------|-------|-------|-------|------|-------------------------|
| | | | | | 3" - 6" |
| | | | | | 4.5" - 10" |
| | | | | | 10" - 16" |
| | | | | | 15" - 24" |
| | | | | | 9.25" - 16.75" Retrofit |



Dektite Universal End Cap

Universal Trapezoidal SSR end cap.

Stock in the following sizes:

| RF801 | RF802 | RF803 | Pipe Range |
|-------|-------|-------|--------------|
| | | | .75" - 2.75" |
| | | | 2" - 7.25" |
| | | | 3.25" - 10" |



OMG Hercules® Roof Drain

The industry's top selling insert drain has a one-piece spun aluminum body that features an extra-large flange for securing the roof cover as well as a depressed sump to enhance flow. Heavy duty cast aluminum clamping ring and strainer dome enhance drain durability and will not rust.

Stock in: 2", 3", 4", 5", 6", 7", 8"



OMG Hercules® PVC Coated Roof Drain

The OMG Hercules drain coated with PVC for direct hot air welding.

Stock in: 3", 4", 5", 6"

Also available in TPO Coating



OMG Hercules® Copper Roof Drain

The OMG Copper Hercules drain features an heavy-duty aluminum dome.

Stock in: 3", 4", 5", 6"

Also available with Vortex Breaker



OMG Hercules® Drain Screwdriver

U-Flow Screwdrivers are used to install U-Flow Seals. The long 317.5 mm shaft ensures ease of reach when tightening the U-Flow Seal connection screws, and all U-Flow screwdrivers come with a loss prevention bar.

Stock in: 1 size



OMG OlyVent

The OMG OlyVent is engineered to prolong the life of the roof system by reducing moisture within the roof system and trapped air pressure within the building. The one-way vent allows trapped air pressure to escape while the two-way breather, combined with the one-way vent, will help reduce moisture.

Stock in: 1-Way Vent or 2-Way Breather



OMG PipeGuard Pipe Supports

Triangular shaped OMG PipeGuard is designed to weather the elements while securely holding rooftop pipes, tubes and conduit at heights between 1.5- and 6-inches off the surface of the roof. Four sizes accommodate 1/2- to 5-Inch diameter pipes, tubes and conduit. All are made from heavy duty EPDM which allows for expansion and contraction.

Stock in: Mini, Small, Tall Small, Large



OMG Height Adjustable & Strut Model Pipeguards

Strut models are available in 6- and 10-inch lengths to support pipes and tubes from 1/2- to 5-inches in diameter at a height of 4-inches off the roof surface. All strut models come with a standard 1 5/8-in. galvanized strut channel to support single or multiple pipes 6-in. strut models are made of heavy duty EDPM rubber.

Stock in: Strut Model, Height Adjustable Strut Model

OMG Height Adjustable & Strut Model Pipeguards - Yellow

Strut models are available in 6- and 10-inch lengths to support pipes and tubes from 1/2- to 5-inches in diameter at a height of 4-inches off the roof surface. All strut models come with a standard 1 5/8-in. galvanized strut channel to support single or multiple pipes 6-in. strut models are made of heavy duty EDPM rubber.

Stock in: Strut Model Yellow, Height Adjustable Strut Model Yellow

OMG PipeFlash - Quad Flash

OMG QuadFlash and WideFlash offer fast and efficient options for sealing individual and clusters of rooftop pipe penetrations. They are permanent, watertight and maintenance free and accommodate penetration expansion and contraction.

Stock in: Black and White

ROOF REPAIR TAPES



Millennium EPDM Flashing Tape

Used for flashing epdm rooftop penetrations, curbs, skylights, elevation changes and other details.

Uncured, .045" EPDM membrane that has been laminated to a 25 mil EPDM based pressure sensitive tape adhesive.

Stock sizes:

5" X 100' | 6" X 100' | 9" X 50' | 12" X 50'



Millennium EPDM Semi-Cured Cover Strip

Used for covering, sealing and protecting EPDM seam overlays and mechanical fastening bars.

Semi-cured, .045" EPDM membrane that has been laminated to a 25 mil EPDM based pressure sensitive tape adhesive

Stock sizes:

5" X 100' | 6" X 100' | 9" X 50' | 12" X 50'



Millennium EPDM Seam Tape

Used for durable, permanent seaming EPDM waterproofing membranes.

.035" EPDM pressure sensitive rubber adhesive tape, designed to provide high strength, watertight seams for single ply EPDM roofing membranes.

Stock sizes:

3" X 100' | 4" X 100' | 6" X 100'



Millennium Reinforced Perimeter Strip

Used for securement of epdm membrane at elevation changes to prevent membrane bridging providing extended service life.

Reinforced, .045" EPDM membrane strip laminated with a 35 mil EPDM based pressure sensitive tape adhesive

Stock sizes: 6" X 100' Roll



TPO White Cover Tape

Non-reinforced, .030" TPO with .030"- .035" seam tape adhesive

Stock size:

6" X 100' Roll



TPO White Seam Tape

.035" TPO adhesive tape for field splicing of TPO membranes

Stock size:

3" X 100' Roll

ROOF REPAIR PRODUCTS AND REPAIR SEALANTS

H.B. Fuller



Millennium EPDM Edge Sealant

Used for sealing exposed edges of epdm membrane roof system seams and flashing details sealing exposed edges of epdm roof system seams and flashing details and other general sealing.

Stock: 10.3 oz. tubes | 12 per case

H.B. Fuller



Millennium Water Block

Used for a permanently flexible secondary sealant in unexposed waterproofing applications.

Stock: 10.3 oz. tubes | 30 per case

H.B. Fuller



Millennium Single Ply Primer

Millennium Single Ply Primer is a rubber based primer with a high viscosity that resists running and thus finds use on both horizontal and vertical surfaces. The primer can be used on both EPDM and TPO membranes and is perfect for installing Cool Cover™ TPO Tapes or Millennium EPDM Tapes.

Stock in: 1 gallon and 3 gallon cans

ETERNA BOND



EternaBond® RoofSeal

Seal any rip, tear, or open seam in any surface with RoofSeal. RoofSeal is the best solution for leak repair. It is the choice of professional roof repair specialists, on virtually all roof types including EPDM, TPO, hypalon, most PVC, modified, all metals, even copper and Kynar coated metals, tile, wood, concrete, etc.

Stock in: Black and White 4" X 50', 6" X 50', 12" X 50'

ETERNA BOND



EternaPrime® Spray

EternaPrime® is an adhesive and surface conditioner intended to aid adhesion of EternaBond® MicroSealant tapes, or other non- MicroSealant tapes such as butyl tapes and other self adhesive seaming tapes. EternaPrime® is also an excellent primer for use with self-adhered modified bitumen membranes.

Stock: 14 oz. cans | 12 per case

ETERNA BOND



EternaClean Spray Cleaner

EternaClean Spray Cleaner is formulated with a proprietary mixture of hot solvents, designed to "open" single-ply roof membranes and metals. Allows the surface to release contaminants like oxidation, grime, oil and grease, tree sap, etc. EternaClean Spray Cleaner leaves no residue, dries fast, and is non chlorinating so it is environmentally friendly and therefore legal in all states.

Stock: 14 oz. cans | 12 per case



ER Systems HER Polyurethane Repair Sealant

ER Systems® H.E.R. is a flashing grade single component moisture-cure polyurethane roof sealant. HER is a tough, seamless elastomeric roofing membrane that has excellent adhesion to a wide variety of substrates. No fabric reinforcement required. Easy to apply and brush. UV stable and time tested since 1977.

Stock in: 10.1 oz tubes (30 per case) | 20 oz. sausages (12 per case) | 1 gallon pails | 2 1/2 gallon pails | 5 gallon pails



ER Systems 2100 MS Adhesive Sealant

ER Systems® 2100MS Adhesive Sealant is a high performance reactive silyl-modified adhesive sealant. It is a one-component moisture-cure sealant that exhibits excellent bond strength after cure. It imparts integral flexibility, superior adhesion and resistance to ultraviolet and infrared radiation. Ease of application, minimum shrinkage, fast skin formation, and primerless adhesion to most building materials and substrates make this an excellent choice for an all purpose sealant.

Stock in: 2 1/2 gallon pails and 20 oz. sausages (12 per case)

APOC ROOF CEMENT, MASTICS, AND ALUMINUM COATING



APOC 122 Dura-Flash All Weather Flashing Cement

APOC 122 DURA-FLASH All Weather Flashing Cement is a professional grade Flashing Cement that provides superior adhesion to vertical surfaces and even bonds to wet or underwater surfaces. It will not run or sag and is formulated for year-round use in adverse weather conditions.

Stock: 3 gallon pails | 5 gallon pails

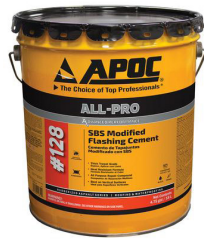

APOC 128 All-Pro SBS Modified Flashing Cement

APOC 128 All-Pro SBS Modified Flashing Cement is a professional grade roof cement that provides superior adhesion to vertical surfaces. It will not run or sag and is formulated for hot weather climates.

Stock: 3 gallon pails | 5 gallon pails



APOC 365 Eterna-Flash All Weather Rubberized Flashing Cement

APOC 365 is an extremely versatile modified mastic that provides superior adhesion to wet surfaces, easily bonds under water and is ideal for temporary or permanent repairs. Durable patching compound under the harshest weather conditions.

Stock: 10.1 oz. tubes | 1 gallon pails | 3 gallon pails

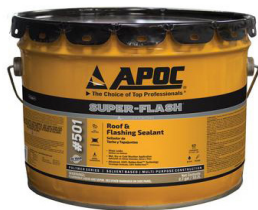

APOC 501 Super-Flash Thermoplastic Flashing Sealant

APOC 501 SUPER-FLASH Roof & Flashing Sealant is a unique professional grade elastomeric flashing and repair product that cures to a long lasting rubber and elastic repair. This 50 year product is designed to provide a flexible seal through extreme temperature ranges.

Stock: 10.5 oz. tubes | 1 gallon pails | 3 gallon pails



APOC 103 Bond N' Prime Asphalt Primer

APOC 103 BOND N' PRIME Asphalt Primer is a professional grade primer formulated with a high penetrating solvent and select asphalt. It is designed to promote superior adhesion of roofing materials.

Stock: 17 oz. aerosol cans



APOC 211 and APOC 212 Aluminum Roof Coating

APOC 211 and 212 are both Premium Non-Fibred Aluminum Roof Coating in a 3 pound professional grade, UL Rated, aluminum reflective coating. APOC 212 is the highest quality aluminum coating on the market.

Stock: 1 gallon pails | 5 gallon pails

OMG RHINO BOND PRODUCTS



OMG RhinoBond®

OMG has introduced a new RhinoBond tool with OptiWeld Technology, providing automatic calibration on membrane up to 80 mils. OptiWeld technology eliminates the calibration process by automatically monitoring the temperature of the RhinoBond Plate during the welding cycle to assure the best bond possible. This saves valuable time and labor for contractors during the daily set-up process.



OMG RhinoBond Hand Welder

This lightweight, portable induction welder is designed to bond RhinoBond plates to TPO and PVC membranes in hard to reach areas such as under rooftop equipment and on vertical surfaces. The stand-alone RhinoBond Hand Welder is ergonomically designed and features a vibrating handle and indicator lights to let users know when the tool is activated and when the weld cycle is complete. The base features a recessed centering design to help users properly align the tool over RhinoBond Plates for optimum bonding.



OMG RhinoBond Heat Sinks

Extra sets of official OMG Heat Sinks are available through PFS.

Efficient and experienced operators can often run more than the 6 heat sinks that come with the tool.

Sold as a set of 6 with carrying case

ADHESIVE DISPENSING EQUIPMENT



OMG Pace Cart 3

Now 2x faster and more reliable, the patented PaceCart 3™ is designed exclusively for dispensing OlyBond 500 insulation adhesives. Highly durable and constructed with roofing contractors in mind, PaceCart 3s are easy to operate & store and are capable of dispensing enough OlyBond 500 to apply up to 120 squares of insulation per hour.



OMG 15 Gallon Pace Cart Conversion Kits

The OMG PaceCart is designed with productivity in mind, and the 15 Gallon Conversion Kit effectively triples the dispensing capacity of PaceCarts for even greater rooftop productivity. The 15 Gallon PaceCart Conversion kit is easy to install, designed to fit on PaceCart 2B and PaceCart 3 equipment, and provides contractors with a more economical option than purchasing new equipment or other retro kits on the market.

Pace Cart 3 Conversion Kit - 123 pounds



Millennium One Step™ Hand Applicators

Manual tool: High-quality, American-made manual applicator tool for OneStep Roofing Adhesive. No batteries, hoses or cords. Simple and efficient operation.

Battery tool: Portable, no cords or hoses. Durable construction, capable of dispensing higher viscosity adhesives. Single piston drive assures on-ratio dispense.



Millennium One Step™ Multi-Bead Applicator

The patented One Step™ insulation adhesive delivery systems have revolutionized the application of insulation and cover board adhesives, while minimizing roof deck penetrations and eliminating thermal bridging from mechanical fasteners. Battery powered, no cords or hoses. Sets adhesive ribbons as prescriptive placement from 3"-12" on center. Durable machine with very low maintenance requirements.

OMG AccuTRAC SYSTEM (MECHANICALLY ATTACHED)



AccuTrac EZ Stand-Up Tool

AccuTrac EZ is the newly redesigned stand-up tool for installing insulation on steel or wood roof decks with 3-in. square AccuTrac plates and certain OMG fasteners, up to 8-inches in length. AccuTrac EZ is ergonomically correct and can minimize operator fatigue by eliminating bending and twisting on the job.



RhinoTrac EZ

RhinoTrac EZ is the newly redesigned stand-up tool for installing RhinoBond Plates on steel or wood roof decks. Contractors can simultaneously drop a RhinoBond plate and drive fasteners up to 8-inches long with RhinoTrac EZ to save time and manpower.



AccuSeam Tool

The OMG AccuSeam System is an ergonomically designed stand-up tool used to install lap seam plates in mechanically attached single-ply systems. This simple and easy-to-operate tool minimizes operator fatigue by eliminating constant bending of the installer.

TERMINATION BAR FASTENING SYSTEM



TermPRO T4 Nailer

The TermPRO Nailer is designed to take productivity to the next level. Up to 6 times faster than traditional fastening methods.

T4 TermPRO Nailer (Tool comes with 2 lithium ion batteries, 1 battery charger, and a case)



TermPRO Pin/Fuel Packs

Each pin/fuel pack comes with 1000 pins and 2 fuel cells. Pins feature a domed head and are coated for long life.

1 1/8" Pin/Fuel Pack

1 1/4" Pin/Fuel Pack



TermPRO Accessories

A full line of accessories are available to keep your TermPRO system in top shape.

- TermPRO T4 Charger
- TermPRO T4 Magnetic Nose Piece
- TermPRO T4 Battery
- TermPRO T4 Fuel Cells

ROOFING POWER TOOLS



Metal Devil Metal Cutting Saws

Metal Devil metal cutting circular saws offer a safer, cleaner way to cut metal. The special motor maintains torque at optimum RPM's for cutting through metal smoothly and efficiently.

7" and 9" models available



DeWalt Hammer Drills

We offer a number of DeWalt hammer drills, including both corded and cordless models. Please check with your local branch for stocking models.



DeWalt Screw Guns

DeWalt screw guns continue to be the workhorse of the roofing trade.



MORE TOOLS ON PAGES 61-62

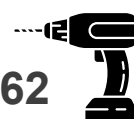

LOOKING FOR SYSTEMS SPECIFIC PARTS?

PRO FASTENING SYSTEMS IS A STOCKING DISTRIBUTOR FOR MULTIPLE ROOFING SYSTEMS MANUFACTURERS. PLEASE CHECK WITH YOUR LOCAL PRO BRANCH FOR YOUR SPECIFIC SYSTEMS NEEDS.

MANUFACTURERS INCLUDE:



ROOF COATINGS



PRIMERS AND BASE COATS | FINISH COATS

ROOF COATING ACCESSORIES

ER SYSTEMS SEALANTS

INLAND COATINGS

ER SYSTEMS PRIMER & BASE COATS



Acrylic Metal Rust Primer

ER Systems® Acrylic Metal Rust Primer is a modified acrylic waterborne primer serving multiple purposes. It may be used as a primer and as a finish coat.

Stock in 5 gallon pails



Polyurethane Metal Rust Primer

ER Systems® Polyurethane Metal Rust Primer is a single component, aluminum pigmented, moisture-cure urethane primer for rusty surfaces.

Stock in 5 gallon pails



Polyurethane 300 Aromatic Base Coat

This product is a liquid applied, single component, moisture-cured polyurethane coating used as a base coat in combination with our Polyurethane 300 Aliphatic Finish Coat.

Stock in 5 gallon pails



Acrylic Asphalt Primer

ER Systems® Acrylic Asphalt Primer is a single component, water-based synthetic polymer elastomeric coating. It provides protection to asphalt substrates and may be applied over fresh asphalt emulsion as a base coat.

Stock in 5 gallon pails



ER SYSTEMS FINISH COATS



Polyurethane 300 Aliphatic Finish Coat

The product is a liquid applied, single component, moisture-cured polyurethane coating used in combination as a finish coat applied over our Polyurethane 300 Aromatic Base Coat.

Color: White

Stock in 5 gallon pails



Acrylic 1000 PLUS

ER Systems® Acrylic 1000 Plus is a single component, water-based acrylic, elastomeric coating.

Color: White or Gray

Stock in 5 gallon pails

ACCESSORIES

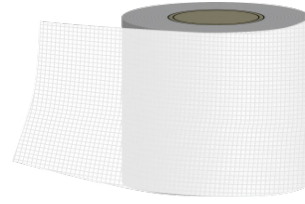

Tie-Tex Stitch Bonded Polyester Fabric

TieTex T272 stitch bonded polyester Fabric rolls are designed to provide support and strength to elastomeric roof coating applications.

Available sizes: 40" X 324' | 6" X 300'

ER SYSTEMS SEALANTS



ER Systems HER Polyurethane Repair Sealant

ER Systems® H.E.R. is a flashing grade single component moisture-cure polyurethane roof sealant. HER is a tough, seamless elastomeric roofing membrane that has excellent adhesion to a wide variety of substrates. No fabric reinforcement required. Easy to apply and brush. UV stable and time tested since 1977.

Stock in: 10.1 oz tubes (30 per case) | 20 oz. sausages (12 per case) | 1 gallon pails | 2 1/2 gallon pails | 5 gallon pails



ER Systems 2100 MS Adhesive Sealant

ER Systems® 2100MS Adhesive Sealant is a high performance reactive silyl-modified adhesive sealant. It is a one-component moisture-cure sealant that exhibits excellent bond strength after cure. It imparts integral flexibility, superior adhesion and resistance to ultraviolet and infrared radiation. Ease of application, minimum shrinkage, fast skin formation, and primerless adhesion to most building materials and substrates make this an excellent choice for an all purpose sealant.

Stock in: 2 1/2 gallon pails and 20 oz. sausages (12 per case)

INLAND COATINGS PRODUCTS



Inland Coatings

Inland offers a full line of roof coatings. Proven since 1978, their products are made to last. Contact your PFS rep for job quotes.

RC 2250 Seam & Repair Product

Reduce the need for 3 coursing! RC-2250 decreases the need for mesh on most seams and penetrations when used on properly prepared surfaces. Effectively protect your roof against alligating and other damaging conditions with the superior RC-2250 SEBS roof repair product. Designed with 400% elongation, 1000 PSI tensile strength and UV stable, Inland's roofing repair solution leaves you with a strong yet flexible membrane that can withstand roof wear of all kinds on seams, fasteners, and penetrations.

Stock in: 1/2 gallon pouches | 1 gallon pails | 2 gallon pails | 5 gallon pails

BUILDING ENVELOPE



FLUID APPLIED AIR BARRIERS

LIQUID APPLIED FLASHINGS AND SEALANTS

**SHEET APPLIED AIR BARRIERS, MEMBRANES,
AND FLASHINGS**

BELOW GRADE WATERPROOFING

ABOVE GRADE WATERPROOFING

WATER REPELLENTS

PROSOCO MASONRY CLEANER

CONSTRUCTION CHEMICALS

FLUID APPLIED AIR BARRIERS

Henry



Henry Air-Bloc 16 MR

Henry® Air-Bloc® 16MR is a fluid applied, vapor impermeable air and water barrier when applied to above-grade wall assemblies. It is single-component, water-based and cures to a tough monolithic rubber-like membrane, which resists air leakage and water penetration.

Stock in 5 gallon pails

Henry



Henry Air-Bloc 17 MR

Spray-, roll- or brush-applied, Henry's Air-Bloc® 17MR is a one-component, rubberized membrane that provides an air barrier when applied to a range of construction surfaces. Air-Bloc® 17MR can be applied down to 20°F (-6°C). Air-Bloc® 17MR cures to a tough, monolithic rubber-like membrane.

Stock in 5 gallon pails

Henry



Henry Air-Bloc All Weather STPE®

A vapor permeable membrane with long-term UV resistance, Henry® Air-Bloc All Weather STPE® is a single-component, moisture cure Silyl Terminated Polyether (STPE) water-resistant air barrier. Featuring a high solids content and quick cure time, Air-Bloc All Weather STPE® can be applied with rain in the forecast, helping to reduce job-site weather delays.

Stock in 5 gallon pails

MASTER BUILDERS SOLUTIONS



MasterSeal AWB 660 I

MasterSeal AWB 660 I is a one component fluid-applied air/ water-resistive barrier that can also function as a Class I vapor retarder. Based on Silica Fortified Rubber™ chemistry, this water-resistant, resilient membrane may be spray-, roller-, or brush-applied directly to approved above grade wall substrates. It provides excellent secondary moisture protection behind most wall claddings including brick, siding, metal panels, EIFS and stucco.

Stock in 5 gallon pails

MASTER BUILDERS SOLUTIONS



MasterSeal AWB 665

MasterSeal AWB 665 is a one component fluid-applied vapor permeable air/ water-resistive barrier based on Silica Fortified Rubber chemistry. This resilient water-resistant coating may be roller-, brush-, spray-applied or jet rolled directly to approved wall substrates

Stock in 5 gallon pails

TREMCO Commercial Sealants & Waterproofing



Tremco ExoAir® 220

ExoAir® 220 Fluid-Applied Permeable Air Barrier Membrane is a monolithic, elastomeric membrane designed to be rolled or sprayed onto exterior above-grade wall assemblies to mitigate air infiltration/exfiltration and water penetration while remaining permeable to the passage of water vapor.

Stock in 5 gallon pails

LIQUID APPLIED FLASHING AND SEALANTS

Henry



Henry Air-Bloc LF

Henry® Air-Bloc® LF is a moisture cure single-component elastomeric liquid-applied flashing using a highly advanced Silyl-Terminated Polyether (STPE) polymer. It is designed to cure through reaction with airborne moisture to provide a heavy-duty, seamless, rubber-like impervious membrane with excellent weathering and water resistance.

Stock in 20 oz. sausages

MASTER BUILDERS SOLUTIONS



MasterSeal AWB 900

MasterSeal AWB 900 is a one-component elastomeric material for use as a flexible flashing membrane. It can also be used to prepare sheathing joints for subsequent application of MasterSeal AWB 660, MasterSeal AWB 665 or MasterSeal AWB 660 I air/water-resistive barrier membranes.

Stock in 20 oz. sausages

TREMCO Commercial Sealants & Waterproofing



Dymonic® 100

Dymonic® 100 is a high-performance, high-movement, single-component, medium-modulus, low-VOC, UV-stable, non-sag polyurethane sealant.

Stock in 20 oz. sausages

Stock colors: Almond, Aluminum Stone, Anodized Aluminum, Beige, Black, Bronze, Buff, Dark Bronze, Gray, Gray Stone, Hartford Green, Ivory, Light Bronze, Limestone, Natural Clay, Off White, Precast White, Redwood Tan, Sandalwood, Stone, and White

LIQUID APPLIED FLASHING AND SEALANTS CONTINUED

Henry

**Henry® 925 BES Sealant**

Henry® 925 BES Sealant is a premium, one-part, low VOC, moisture cure, building envelope sealant for construction joints subject to dynamic joint movement.

Stock in 10.3 oz. cartridges and 20 oz. sausages in White, Black, and Grey

Henry

**Henry® 212 All Purpose Crystal Clear Sealant**

Henry® 212 All Purpose Crystal Clear Sealant is a one-part, highly elastic, high-performance thermoplastic sealant. The sealant exhibits excellent adhesion to a variety of construction materials. It can be applied to wet or dry surfaces and has excellent low temperature flexibility.

Stock in 10.3 oz.. cartridges



NEED DISPENSING TOOLS? CHECK OUT PAGE 20 FOR SOME OPTIONS!

SHEET APPLIED AIR BARRIERS, MEMBRANES, AND FLASHINGS

Henry

**Henry Blueskin SA**

Blueskin® SA is a self-adhering membrane consisting of an SBS rubberized asphalt compound laminated on a blue polyethylene film. Impermeable to air, moisture vapor and water, Blueskin® SA is designed to install easily on a variety of prepared substrates.

Stock in: 4", 6", 9", 12", 18", 36", 48" X 75' rolls

Henry

**Henry Blueskin VP160**

Henry® Blueskin® VP160 is a self-adhered vapor permeable, water resistive air barrier membrane consisting of an engineered film and a patented, permeable adhesive technology with split-back poly-release film. Blueskin® VP160 is fully adhered to the wall substrates in a weatherboard method without mechanical attachment.

Stock in 48" X 100' rolls

Henry

**Henry® Blueskin® Metal Clad®**

Henry® Blueskin® Metal Clad® is a self-adhered water resistive air barrier membrane comprised of rubberized asphalt and dual-layers of high strength polyethylene with surface layer of metallic aluminum film.

Stock in 4", 6", 9", 12", 18" X 66.7' rolls

Henry

**Henry Blueskin® WP200**

Blueskin® WP 200 is a self-adhered composite membrane consisting of an SBS rubberized asphalt compound, integrally laminated to a blue, high-density polyethylene film. The membrane is specifically designed for self-adhering to a prepared substrate, and provides a high-performance waterproofing barrier.

Stock in 36" X 66.7' rolls

Henry

**Henry Blueskin® Thru-Wall Flashing**

Henry® Blueskin® TWF is a self-adhered membrane consisting of an SBS rubberized asphalt compound, which is integrally laminated to a yellow cross-laminated polyethylene film. The membrane is specifically designed for use as a thru-wall flashing.

Stock in 12", 18", and 24" X 75' rolls

Henry

**Henry® Blueskin® Butyl Flash**

Blueskin® Butyl Flash is a self-adhered flashing consisting of a synthetic butyl compound which is integrally laminated to a white engineered polypropylene film surface. The flashing is specifically designed to be self-adhered to a prepared substrate.

Stock in 6", 9", 12" X 75' rolls

Henry



Henry® 571 Blueskin® Adhesive

Blueskin® Adhesive is a quick drying, rubber-based adhesive designed to enhance the adhesion of self-adhered membranes, such as Blueskin® SA.

Stock in 5 gallon pails

MASTER BUILDERS SOLUTIONS



MasterSeal AWB 970 FIP

MasterSeal AWB 970 FIB is a patented, 30-mil thick, self-adhering, self-sealing, composite membrane of polyester fabric and rubberized asphalt. MasterSeal AWB 970 FIB is supplied in rolls, on release paper, for easy application.

Stock in 4" X 100' X 30 mil roll | 9" X 100' X 30 mil roll

TREMCO Commercial Sealants & Waterproofing



Tremco ExoAir® 110AT

ExoAir® 110AT is a 22-mil composite impermeable membrane that is comprised of 16 mils of butyl and 6 mils of HDPP facer. It can be used as the membrane, detailing accessory, as well as thru-wall flashing of an air barrier system.

Stock in 4", 9", 18", 36" X 75' rolls

Henry



Henry® PE200HT High Temperature Roof Underlayment

Henry® Blueskin® PE200HT High Temperature Roof Underlayment is a specification-grade, self-adhered roofing underlayment consisting of a high softening point, SBS rubberized asphalt compound, which is integrally laminated to a blue cross-laminated polyolefin film with slip-resistant coating

Stock in 36" X 65' rolls (195 square feet)

Henry



Henry® modifiedPLUS NP180 Base Sheets

modifiedPLUS NP180 Base Sheets are designed for use as the base or first ply in a high performance two-ply modified bitumen roofing system, or as a ply in two-ply Protected Membrane roofing system. Additionally, it can be used as a reinforcing sheet in 790-11 Hot Applied Rubberized Asphalt Systems.

Stock in NP180 S/S 1M X 15M Roll

Henry



Henry® Bakor Elastomeric Flashing Sheet Unreinforced

990-25 Elastomeric Flashing Sheet is a flexible flashing membrane composed of combination of butyl and EPDM polymers. Compatible with asphalt roofing and waterproofing materials.

Stock in 12" X 75' X 47 MIL Rolls

IPCO

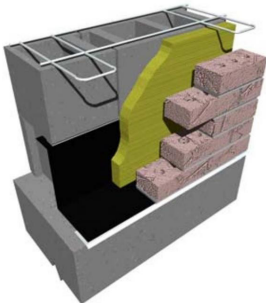

IPCO Self-Adhesive Rubberized Asphalt Flashing

IPCO Flashing consists of rubberized asphalt waterproofing laminated to a tough 4 mil high-density, cross laminated polyethylene film.

Stock in 6" X 40 Mil X 75' Roll, 12" X 40 Mil X 75' Roll, 16" X 40 Mil X 75' Roll, 16" X 30 Mil X 100' Roll, 18" X 40 Mil X 75' Roll

IPCO

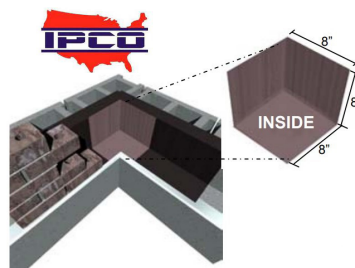

IPCO Flashing Accessories

Stock Accessories Include:

- Preformed Flashing Corners - Self Adhesive Rubberized Asphalt, Stainless Steel, or Copper
- End Dam Flashings - Self Adhesive Rubberized Asphalt, Stainless Steel, or Copper
- Butt Joint Covers
- Drip Edge - Drip Edge in stainless steel and copper provide for a clean and effective finish to the flashing installation.
- Flashing Mastic - Quart Tubes
- Rubber Based Adhesive Primer - Gallon

IPCO

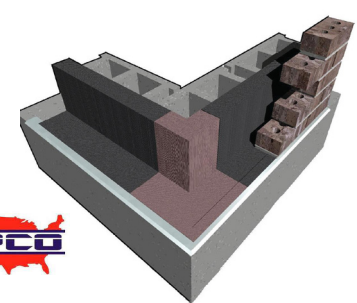

SHEET APPLIED AIR BARRIERS, MEMBRANES, AND FLASHINGS CONTINUED



Henry



Henry

**Henry® 790-11 Hot Rubberized Asphalt**

Henry® Company's time-tested 790-11 hot rubberized, fluid asphalt is formulated to provide a monolithic, fully bonded roofing and waterproofing membrane. 790-11 is an excellent choice when waterproofing both intensive and extensive vegetative roofing assemblies.

Stock in 50 pound units

Henry® modifiedPLUS® G100 Series

Henry® modifiedPLUS® G100 is designed for use as the base or first ply in a high performance two-ply modified bitumen flashing membrane, or as the protection sheet in Henry® green roof or protected membrane systems.

Stock in 1M X 15M Roll

Henry® Drain Board DB200S

Henry Drain Board products are designed to manage the flow of water, allowing for water to be directed away from the building structure.

Stock in 4' X 50' roll

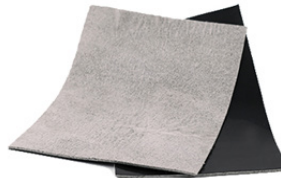
**Tremco Paraseal®**

Paraseal® is a sheet waterproofing membrane consisting of 15 mils of HDPE and expandable, granular bentonite. The composite weight of the material is up to 1.0 lb/ft², creating a dual waterproofing system.

Stock in 4' X 24' rolls

Tremco Paraseal® LG

Paraseal® LG is a sheet waterproofing membrane consisting of 20 mils of HDPE, expandable, granular bentonite and a protective layer of spun-bonded polyester. The composite weight of the material is up to 1.0 lb/ft², creating a dual waterproofing membrane.

Stock in 4' X 24' rolls

TREMDrain™ 1000NW

TREMDrain 1000 NW is designed for single-sided subsurface vertical drainage applications requiring a typical non-woven filter fabric bonded to a high compressive strength and high flow capacity formed core.

Stock in 4' X 50'

BELOW GRADE WATERPROOFING

Henry



MASTER BUILDERS SOLUTIONS



TREMCO Commercial Sealants & Waterproofing



TREMCO Commercial Sealants & Waterproofing

**Henry® CM100**

Henry® CM100 is a fast curing, one component elastomeric, solvent-free, moisture cure roofing and waterproofing membrane and is a great choice for green roofing. It provides a cold alternative to hot applied rubberized membrane systems or replaces conventional hot mop, felt ply and/or pre-formed sheeting systems.

Stock in 5 gallon pails

MasterSeal HLM 5000

MasterSeal HLM 5000 is a one-component, moisture-curing, bitumen-modified polyurethane elastomeric waterproofing membrane for exterior below-grade or between-slab applications.

Stock in 5 gallon pails of Roller Grade or Trowel grade

TREMPROOF® 250GC

TREMPROOF® 250GC is a rapid-curing, high-solids, VOC-compliant modified polyurethane waterproofing membrane that can be applied to damp and green concrete. TREMPROOF 250GC is a one-part moisture-curing elastomer available in three viscosities: Self-Leveling (SL), Roller (R) and Trowel (trowel intended for detailing work only).

Stock in 5 gallon pails of Roller Grade and 5 gallon pails of Self-Leveling

Vulkem® 191 Primer

Vulkem® 191 Primer is a quick drying, one-part, moisture-curing primer used as a urethane-to-urethane tie-in that prepares surfaces of cured Vulkem urethane sealants, coatings and membranes to be sealed with a fresh coat

Stock in 1 quart cans, 1 gallon cans, 5 gallon cans



ABOVE GRADE WATERPROOFING



DOWSIL™ ALLGUARD Sili-cone Elastomeric Coating Mid Tint Base

Designed to waterproof above-grade exterior masonry substrates, such as concrete block, fluted block, brick, stucco, synthetic stucco, poured concrete, precast concrete, exterior insulation finish systems (EIFS) and previously coated masonry substrates.

Stock in 5 gallon pails



DOWSIL™ ALLGUARD Primer

Water-based silicone adhesion promoter for use with DOWSIL™ AllGuard Silicone Elastomeric Coating.

Stock in 5 gallon pails



MasterProtect HB 400

MasterProtect HB 400 is a breathable, high-build, 100% acrylic, waterproof coating for above grade applications Water-based. For above-grade concrete, masonry, stucco, and EIFS.

Stock in 5 gallon pails

WATER REPELLENTS



MasterProtect H 1000

MasterProtect H 1000 is a clear, breathable, high-performance, 100% silane, water repellent sealer that achieves highest depth of penetration.

Stock in 5 gallon pails



MasterProtect H 177

MasterProtect H 177 is a high-performance, water-based, VOC-compliant, clear silane/siloxane sealer designed for dense, vertical masonry surfaces like hard-burnt brick.

Stock in 5 gallon pails



MasterProtect H 185

MasterProtect H 185 is a high-performance, water-based, clear, silane/siloxane sealer designed to provide long-term protection for the most challenging split-faced and lightweight block as well as standard CMU.

Stock in 5 gallon pails

PROSOCO MASONRY CLEANERS



Vana Trol

Sensitive brick & stone cleaner
Vana Trol is a concentrated acidic cleaner for new masonry surfaces that are subject to vanadium, manganese and other metallic stains. Vana Trol is designed to simplify rinsing and reduces the potential for efflorescence.

Stock in 5 gallon pails



Sure Clean 600

New masonry cleaner
600 is a general-purpose, concentrated acidic cleaner that dissolves mortar smears and construction dirt quickly, leaving the masonry clean and uniform with no acid burning or streaking. 600 is the No. 1-selling proprietary cleaner for new masonry and is recommended by many brick, block, tile and mortar manufacturers.

Available in 1 gallon and 5 gallon pails

CONSTRUCTION CHEMICALS



Xylo

Stock in 1 gallon units



Isopropyl Alcohol

Stock in 1 gallon units



WE ALSO STOCK ALL THE ACCESSORIES YOU WILL NEED TO GET THE JOB DONE. JUMP TO PAGE 57 TO FIND OUR CONTRACTOR GRADE ACCESSORIES!

RIVETS



**BLIND RIVETS | STAINLESS PAINTED RIVETS
COPPER AND BRASS RIVETS | COUNTERSUNK
BULB-TITE | KLIK-LOCK | FAB-LOK**



Aluminum/Aluminum Blind Rivets

Open-end, buttonhead, all aluminum rivets, stock in these sizes:

| 1/8" Diameter | 5/32" Diameter | 3/16" Diameter |
|----------------------|----------------------|-----------------------|
| #42 (.063-.125 grip) | #52 (.020-.125 grip) | #62 (.020-.125 grip) |
| #44 (.188-.250 grip) | #54 (.188-.250 grip) | #64 (.126-.250 grip) |
| #46 (.313-.375 grip) | #56 (.251-.375 grip) | #66 (.251-.375 grip) |
| #48 (.376-.500 grip) | #58 (.376-.500 grip) | #68 (.376-.500 grip) |
| | | #610 (.501-.625 grip) |

Additional sizes available! Check with your local PFS branch.



Steel/Steel Blind Rivets

Open-end, buttonhead, plated steel rivets, stock in these sizes:

| 1/8" Diameter | 3/16" Diameter |
|----------------------|----------------------|
| #42 (.063-.125 grip) | #62 (.020-.125 grip) |
| #44 (.188-.250 grip) | #64 (.126-.250 grip) |
| #46 (.313-.375 grip) | #66 (.251-.375 grip) |
| #48 (.376-.500 grip) | #68 (.376-.500 grip) |

Additional sizes available! Check with your local PFS branch.



Stainless/Stainless Blind Rivets

Open-end, buttonhead, stainless steel rivets, stock in these sizes:

- | | |
|----------------------|-----------------------|
| 1/8" Diameter | 3/16" Diameter |
| #42 (.063-.125 grip) | #62 (.020-.125 grip) |
| #43 (.126-.187 grip) | #64 (.126-.250 grip) |
| #44 (.188-.250 grip) | #66 (.251-.375 grip) |
| #46 (.313-.375 grip) | #68 (.376-.500 grip) |
| #48 (.376-.500 grip) | |



Factory Painted Stainless Steel

Open-end, buttonhead, stainless steel rivets, factory painted, stock in these sizes:

- | | |
|---|---|
| #43 (.126-.187 grip) | #44 (.188-.250 grip) |
| Bright White, Charcoal Gray, Pearl Gray, Warm White, Beige, Regal Blue, Champagne Metallic, Silver Metallic | Charcoal Gray, Colonial Red, City Scape, Dark Bronze, Evergreen, Hartford Green, Matte Black, Mansard Brown, Patina Green, Seal Brown, Slate Gray, Sandstone, Sierra Tan, Regal White |



Custom Painted Rivets

We can custom paint rivets to match any color! We have been painting fasteners and rivets in our Arlington Heights, IL headquarters for over 35 years!



Copper Rivets/Brass Mandrel

Open-end, buttonhead, copper rivets with brass mandrels, stock in these sizes:

- #42 (1/8" diameter, .063-.125 grip)
- #44 (1/8" diameter, .063-.125 grip)



Copper Rivets/Copper Mandrel

Open-end, buttonhead, copper rivets with copper plated mandrels, stock in these sizes:

- #42 (1/8" diameter, .063-.125 grip)
- #44 (1/8" diameter, .063-.125 grip)



Aluminum Countersunk Rivets

120 degree countersunk head, all aluminum rivet and mandrel, stock in these sizes:

- #64 (3/16" diameter, .151-.250 grip)
- #66 (3/16" diameter, .251-.375 grip)
- #68 (3/16" diameter, .376-.500 grip)



FAB-LOK® Fasteners

Fab-Lok fasteners combine a screw and a slotted aluminum sleeve to provide resistance to loosening in high-stress and high-vibration environments. Available in the following sizes:

- Stainless Steel .062-.250 (EZJ210)
- Stainless Steel .250-.500 (EZJ230)
- Stainless Steel .500-.750 (EZJ250)
- Carbon Steel .062-.250 (EZJ100)
- Carbon Steel .250-.500 (EZJ120)
- Carbon Steel .500-.750 (EZJ140)



BULB-TITE® Rivet (3/16")

Ideal for metal roof attachments, facade panel to metal, and polycarbonate panel to metal. Tamper resistant, Won't loosen in high vibration or fatigue applications. Available in the following sizes:

- RV6604-6-4W (.062-.250 grip)
- RV6604-6-6W (.187-.375 grip)
- RV6604-6-8W (.312-.500 grip)
- RV6604-6-10W (.437-.625 grip)
- RV6604-6-12W (.563-.750 grip)



Klik-Lock® Rivets

Solid circle lock is created between the body and mandrel, creating a weather-resistant assembly that virtually eliminates pin push out. Available in the following sizes:

- Aluminum 64 Buttonhead (.062-.270 grip)
- Aluminum 67 Buttonhead (.214-.437 grip)
- Aluminum 6E Buttonhead (.062-.437 grip)
- Aluminum 66 Countersunk (.125-.331 grip)
- Aluminum 69 Countersunk (.305-.500 grip)
- Aluminum 812 Countersunk (.415-.725 grip)
- Stainless 64 Buttonhead (.062-.270 grip)
- Stainless 86 Buttonhead (.080-.375 grip)
- Stainless 810 Buttonhead (.350-.625 grip)



Rivet Installation Tools

Gesipa PowerBird Pro: 18.5 Volt, Cordless Riveting Tool Kit, W/ Battery Charger Carry Case

Marson HP-2: Known and trusted for durability, quality and performance, the HP-2 is often copied but never equaled. It's square shoulder fulcrum pin of cold-formed heat treated steel prevents pin rotation. Other quality features include: precision die cast, high strength aluminum alloy body; drop forged carbon steel upper handle; and thick cushion-molded vinyl grips for comfort. The HP-2 sets up to 3/16" steel rivets and comes with four mounted nosepieces (3/32", 1/8", 5/32", and 3/16") and a service wrench.

CONCRETE FASTENING



ULTRACON®+ | AGGRE-GATOR® | TAPCON
ZAMACS | MECHANICAL ANCHORS | DROP-INS
EPOXY | GAS & POWDER LOADS AND PINS
SAMMYS FOR CONCRETE | DRILLING

MECHANICAL ANCHORS



DEWALT



DEWALT

ULTRACON®+ Concrete Screw Anchor

The UltraCon+ fastening system is a complete family of screw anchors for light to medium duty applications in concrete, masonry block, brick, and wood base materials.

Stock HWH Sizes:

| | |
|----------------|---------------|
| 3/16" X 1 1/4" | 1/4" X 1 1/4" |
| 3/16" X 1 3/4" | 1/4" X 1 3/4" |
| 3/16" X 2 1/4" | 1/4" X 2 1/4" |
| 3/16" X 2 3/4" | 1/4" X 2 3/4" |
| 3/16" X 3 1/4" | 1/4" X 3 1/4" |
| 3/16" X 3 3/4" | 1/4" X 3 3/4" |
| 3/16" X 4" | 1/4" X 4" |
| | 1/4" X 5" |
| | 1/4" X 6" |

Stock PFH Sizes:

| | |
|----------------|---------------|
| 3/16" X 1 1/4" | 1/4" X 1 1/4" |
| 3/16" X 1 3/4" | 1/4" X 1 3/4" |
| 3/16" X 2 1/4" | 1/4" X 2 1/4" |
| 3/16" X 2 3/4" | 1/4" X 2 3/4" |
| 3/16" X 3 1/4" | 1/4" X 3 1/4" |
| 3/16" X 3 3/4" | 1/4" X 3 3/4" |
| 3/16" X 4" | 1/4" X 4" |
| | 1/4" X 5" |
| | 1/4" X 6" |

ULTRACON® SS4 410 Stainless

The UltraCon SS4 anchor is a 410 stainless steel screw anchor for light to medium duty applications in concrete and masonry block base materials. The screw anchor is fast and easy to install and provides a neat, finished appearance.

Stock HWH Sizes:

| | |
|----------------|---------------|
| 3/16" X 1 1/4" | 1/4" X 1 1/4" |
| 3/16" X 1 3/4" | 1/4" X 1 3/4" |
| 3/16" X 2 1/4" | 1/4" X 2 1/4" |
| 3/16" X 2 3/4" | 1/4" X 2 3/4" |
| | 1/4" X 3 1/4" |
| | 1/4" X 3 3/4" |
| | 1/4" X 4" |
| | 1/4" X 5" |
| | 1/4" X 6" |

Stock PFH Sizes:

| | |
|----------------|---------------|
| 3/16" X 1 1/4" | 1/4" X 1 1/4" |
| 3/16" X 1 3/4" | 1/4" X 1 3/4" |
| 3/16" X 2 1/4" | 1/4" X 2 1/4" |
| | 1/4" X 2 3/4" |
| | 1/4" X 3 1/4" |



ULTRACON® PHILLIPS FLAT TRIMFIT HEAD

The Zamac Nailin is a nail drive anchor which has a body formed from Zamac alloy. The anchor is available with a stainless steel nailin.

Available in the following:

5/16" diameter, up to 5"



AGGRE-GATOR®

300 series stainless bi-metal concrete and masonry fasteners. Aggre-gator anchors provide unmatched corrosion resistance in demanding applications.

Stock HWH Sizes: Stock PFH Sizes:

- | | |
|---------------|---------------|
| 1/4" X 1 1/4" | 1/4" X 1 1/4" |
| 1/4" X 1 3/4" | 1/4" X 1 3/4" |
| 1/4" X 2 1/4" | 1/4" X 2 1/4" |
| 1/4" X 2 3/4" | 1/4" X 2 3/4" |
| 1/4" X 3 1/4" | 1/4" X 3 1/4" |
| 1/4" X 4" | 1/4" X 4" |



ITW Tapcon® Anchors

The new Tapcon screw anchor is more reliable than ever, minimizes rework and helps you get the job done faster. No matter the substrate, tool, or your experience level, Tapcon installs right the first time, every time.

Stock sizes:

Available in both HWH and Flat Head



ZAMAC NAILIN®

The Zamac Nailin is a nail drive anchor which has a body formed from Zamac alloy. The anchor can be used for light duty, tamperproof applications. The anchor is not recommend for overhead, life-safety or sustained tensile loading applications.

Stock sizes:

- 3/16" X 7/8" | 1/4" X 1" | 1/4" X 1 1/4" | 1/4" X 1 1/2" | 1/4" X 2"



ZAMAC NAILIN® Stainless Nailin

The Zamac Nailin is a nail drive anchor which has a body formed from Zamac alloy. The anchor is available with a stainless steel nailin.

Stock sizes:

- 1/4" X 1" | 1/4" X 1 1/4" | 1/4" X 1 1/2" | 1/4" X 2"



SPIKE® Mushroom Head Anchor

The Spike is a, one-piece, vibration resistant anchor for use in concrete block or stone. Several head styles, including tamperproof versions, and anchor materials are available.

Available in the following:

Carbon Steel: 3/16" - 1/2" diameter, lengths up to 6 1/2"

Stainless Steel: 3/16" - 3/8" diameter, lengths up to 3"



DRIVE® TIE-WIRE

The Drive is a one-piece, tamperproof, pre-formed anchor available in carbon steel for use in concrete. Tie-Wire Drive anchors are designed for suspended ceiling applications.

Stock in:

1/4" X 1 3/4"



POWER-STUD®+ Wedge Anchors

The Power-Stud+ SD2 anchor is a fully threaded, torque-controlled, wedge expansion anchor which is designed for consistent performance in cracked and uncracked concrete.

Available in the following diameters:

3/8", 1/2", 5/8", and 3/4" and in lengths up to 8 1/2"



POWER-STUD®+ SD4 Stainless

The Power-Stud+ SD4 anchors are fully threaded, torque-controlled, stainless steel wedge expansion anchors which are designed for consistent performance in cracked and uncracked concrete.

Available in the following diameters:

1/4", 3/8", 1/2", 5/8", and 3/4" and in lengths up to 10"



MECHANICAL ANCHORS CONTINUED

DEWALT**LOK-BOLT AS®**

The Lok-Bolt AS is an all-steel pre-assembled single unit sleeve anchor which is designed for use in concrete or masonry base materials. The anchors are available in multiple head styles for multiple applications and a finished appearance.

Available in the following diameters:

3/8", 1/2", 5/8", 3/4", and in lengths up to 8 1/4"

DEWALT**POWER-BOLT®+**

The Power-Bolt+ anchor is a torque controlled, heavy duty sleeve style anchor which is designed for consistent performance in cracked and uncracked concrete.

Available in the following diameters:

1/4", 3/8", 1/2", 5/8", and in lengths up to 8 1/4"

DEWALT**SCREW-BOLT+™**

The Screw-Bolt+ anchor is a one piece, heavy duty screw anchor with a finished hex head or flat head (countersunk). It is simple to install, easy to identify and fully removable.

Available in the following diameters:

1/4", 3/8", 1/2", 5/8", and 3/4" and in lengths up to 8"

DROP-IN ANCHORS

DEWALT**SMART DI**

The Smart DI is an all-steel, machine bolt anchor available in carbon steel. It can be used in solid concrete, hard stone, and solid block base materials.

Available in the following internal thread diameters:

1/4", 3/8", 1/2"

DEWALT**HOLLOW-SET DROP-IN™**

The Hollow-Set Drop-in anchor is designed for anchoring in hollow base materials such as hollow concrete block and precast hollow core plank. It can also be used in solid base materials.

Available in the following internal thread diameters:

1/4", 5/16", 3/8", 1/2", 5/8"

DEWALT**MINI DROP-IN™**

The Mini Drop-in is a carbon steel machine bolt anchor for use in shallow embedment applications. In addition to solid concrete and precast hollow core plank, it can be used in post-tensioned concrete slabs and concrete pours over steel deck.

Available in the following internal thread diameters:

1/4", 3/8", 1/2"

DEWALT**STEEL DROP-IN™**

The Steel Drop-in is an all-steel, machine bolt anchor available in carbon steel and two types of stainless steel. It can be used in solid concrete, including lightweight concrete and concrete-filled steel deck members.

Available in the following internal thread diameters:

1/2", 3/4"

DEWALT**STEEL DROP-IN™ (LIPPED)**

The Steel Drop-in is an all-steel, machine bolt anchor available in carbon steel and two types of stainless steel. It can be used in solid concrete, including lightweight concrete and concrete-filled steel deck members.

Available in the following internal thread diameters:

1/4", 3/8", 1/2"

DEWALT**DI SYSTEM SETTING TOOL**

Setting tools specifically designed for setting drop-in fasteners properly.

Available in the following sizes:

1/4", 3/8", 1/2"

DON'T SEE WHAT YOU ARE LOOKING FOR? GIVE US A CALL! WE HAVE DECADES OF EXPERIENCE AND CAN HELP YOU FIND THAT SPECIALTY PRODUCT YOU ARE LOOKING FOR.



CHEMICAL ANCHORS



AC100+ GOLD®

The AC100+ Gold is a two-component vinyl ester adhesive anchoring system. The system includes injection adhesive in plastic cartridges, mixing nozzles, dispensing tools and hole cleaning equipment. The adhesive is designed for bonding threaded rod and reinforcing bar elements into drilled holes in concrete and masonry base materials.

Available in:

9.5 Fl Oz. Quik-Shot and 28 Fl. Oz. Dual Cartridge



PURE50+™

The Pure50+ is a two-component adhesive anchoring system. The system includes injection adhesive in plastic cartridges, mixing nozzles, dispensing tools and hole cleaning equipment. The Pure50+ is designed for bonding threaded rod and reinforcing bar hardware into drilled holes in solid concrete base materials.

Available in:

9 Fl Oz. Quik-Shot, 20.5 Fl. Oz. Cartridge, and 50.5 Fl Oz. Cartridge



Red Head A7+ Quick-Cure Adhesive

Red Head A7+ is a high-strength, fast-cure adhesive that is designed to securely anchor threaded rod and rebar to cured concrete and masonry. A7+ is one of the most versatile anchoring solutions on the market, suitable for use in an extremely wide range of applications and environmental conditions.

Available in:

5 oz., 9.5 oz., and 28 oz. sizes

GAS TOOL FASTENERS AND POWDER ACTUATED FASTENERS



Gas Tool Fasteners

A variety of pins are available for the T3SS and T4SS tool from ITW Ramset, including threaded rod hangers, one hole straps, conduit clamps, ceiling clip assemblies, tie strap holders, washered pins, and top hat pins. All with the power and convenience of fuel cell technology.



Drive Pins

Drive pins with a 0.300" diameter head are designed for permanently fastening a fixture to concrete, concrete over steel deck, concrete masonry walls and A36 or A572 / A992 structural steel. The fasteners are manufactured with a 0.145" diameter shank in various lengths.

Available in:

1/2" to 3"



Powder Loads

DEWALT offers high quality powder loads, designed for consistency and reliability. Specific load types are designed for each caliber powder actuated tool.

Available in the following colors:

Brown, Green, Purple, Red, Yellow

SAMMYS FOR CONCRETE



SAMMYS®

SAMMYS for concrete feature an easy two step process (Drill hole & drive anchor). A concrete installation tool available for a one tool installation process. Available in vertical mount, horizontal mount, and swivel mount threaded rod applications.

CONCRETE DRILLING



DeWalt Hammer Drills

We offer a number of DeWalt hammer drills, including both corded and cordless models. Check out pages 61 and 62 for more hammer drill options.



Masonry Drill Bits

We stock a HUGE selection of masonry drill bits from 3/16" diameter thru 1".

DRYWALL PRODUCTS



RAMSET T4 | RAMSET TRAKFAST | RAMSET GYPFAST DRYWALL SCREWS CEMENT BOARD SCREWS | DEC-KING HOLLOW WALL ANCHORS



RED HEAD
Ramset Buildex
Commercial Construction



Ramset T4MAG Gas System

The Power of the T4MAG allows you to consistently shoot where no other gas tool has gone before. The .125 diameter pin is specifically engineered to work in the toughest concrete and steel where other pins cannot perform.

T4MAG System Includes:

T4MAG Tool (includes 2 batteries, charger, case)

1/2" Pin/Fuel Packs

3/4" Pin/Fuel Packs

1" Pin/Fuel Packs



RED HEAD
Ramset Buildex
Commercial Construction



Ramset TrakFast TF1200 Gas Tool and Pins

Since its introduction in 1991, the TrakFast tool has been the tool of choice for interior framing contractors.

TrakFast TF1200 System Includes:

TF1200 Tool (includes 2 batteries, charger, case)

1 1/2" Pin/Fuel Packs

2 1/2" Pin/Fuel Packs



RED HEAD
Ramset Buildex
Commercial Construction



Ramset GypFast G2

The fastest method for attaching exterior sheathing! Fully automatic coil system is 3 to 5 times faster than screw attached methods. An aggressive nail shank design provides high performance data in both pullout and shear conditions.

GypFast G2 System Includes:

GypFast G2 Tool (includes 2 batteries, charger, case)

1/2" Pin/Fuel Packs

3/4" Pin/Fuel Packs

1" Pin/Fuel Packs

Coarse Thread Drywall Screws

Phillips Bugle Head

Stock in the following sizes:

1 1/4", 1 5/8", 2", 2 1/2", 3"

Fine Thread Drywall Screws

Phillips Bugle Head

Stock in the following sizes:

1 1/4", 1 5/8", 2", 2 1/4", 2 1/2", 3"

Self-Drilling, Zinc Plated

Phillips Bugle Head

Stock in the following sizes:

1 1/8", 1 1/4", 1 5/8", 1 7/8", 2 3/8", 2 5/8", 3"

Lath Head (Mod Truss) Sharp Point

Phillips Drive Zinc Plated

Stock in the following sizes:

1/2", 3/4", 1", 1 1/4", 1 5/8", 1 7/8", 2 1/2", 3"

Lath Head (Mod Truss) Self Drill

Phillips Drive Zinc Plated

Stock in the following sizes:

1/2", 3/4", 1", 1 1/4", 1 5/8", 1 7/8", 2 1/2", 3"

Pan Head Framing Screws

Phillips Pan Head

Stock in the following sizes: 7/16"

Pan Head Framing Screws DS

Phillips Pan Head, Zinc Plated

Stock in the following sizes: 7/16"

Rock-On Cement Board Screws

Phillips Drive, Climacoat

Stock in the following sizes:

Type S Point: 1 1/4", 1 5/8", 2 1/4"

Self-Drill: 1 1/4", 1 5/8", 2 1/4"

Dec-King® Wood Screws

Phillips or Square Bugle Head, Climacoat

Stock in the following sizes:

1 1/4", 1 5/8", 2", 2 1/2", 3"

E-Z ANCOR® ZINC

Predrills precise hole in gypsum wall board. Provides strong engagement in 3/8, 1/2 or 5/8 gypsum wallboard. Only requires a Phillips screw driver.

100 per box with or without screws

E-Z ANCOR® PLASTIC PLUS

Predrills precise hole in gypsum wall board. Provides strong engagement in 3/8, 1/2 or 5/8 gypsum wallboard. Only requires a Phillips screw driver.

100 per box with or without screws

E-Z ANCOR® MINI

Mini version of the EZ Anchor. 30 pounds of holding capability.

100 per box

WE SELL COMMERCIAL GRADE FASTENERS! CONSISTENT PERFORMANCE AND TOP VALUE IS WHAT YOU WILL GET FROM PRO FASTENING SYSTEMS.

HARDWARE



THREADED ROD | UNISTRUT
STRUT ACCESSORIES | SAMMYS | GRIPPLE
HH CAP SCREWS | NUTS | WASHERS
SMS | LAG SCREWS | CARRIAGE BOLTS
HHTB | MACHINE SCREWS | GUTTER SCREWS



Threaded Rod

Stock sizes:

1/4"-20 X 10' Zinc | 3/8"-16 X 10' Zinc | 1/2"-13 X 10' Zinc

Selected sizes also available in 6' and 12' lengths.

Also available, stainless steel threaded rod in select diameters and lengths.

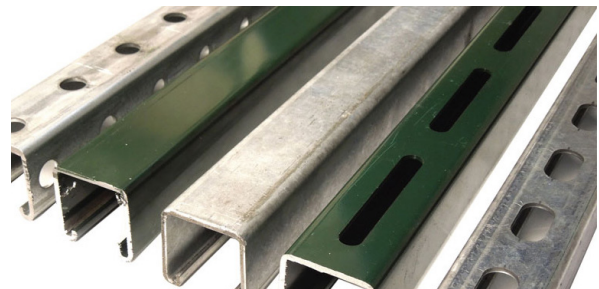

Unistrut

Stock sizes and styles include:

14 and 12 Gauge Strut - Green and Galvanized - Shallow/Standard/Deep - Welded Back-to-Back - 10' and 20' Lengths



Strut Accessories

Stock accessories include:
Strut Nuts | Strut Washers | Pipe Clamps



Sammys ® Threaded Rod Anchors

Sammys ® are a line of specialty fasteners used for threaded rod hanging. A variety of styles exist including Sammys for wood, concrete, metal, Sidewinders, and the XPress line.

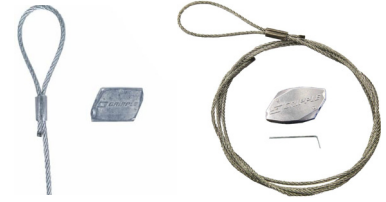

Gripplle

Patented suspension systems for the installation of HVAC, mechanical, lighting, electrical, and signage services. A faster, safer, more cost effective and energy efficient alternative to threaded rod and strut.



Hex Head Cap Screws

We stock many standard diameters and lengths of HHCS. Certain sizes also available in stainless steel or structural grade.



Hex Nuts

We stock all the standards in bulk! In addition we also stock nylon insert lock nuts, heavy hex nuts, stainless steel and more.



Washers

We stock USS flatwashers in all the standards. We also carry an extensive line of fender washers, split lockwashers, stainless steel washers and more.



Sheet Metal Screws

#6 diameter thru #14 diameter sheet metal screws. Pan heads, hex heads, flat heads, and more.



Lag Screws

We stock hex head lag screws in many standard diameters.



Carriage Bolts

We stock carriage bolts in many standard diameters.



Hex Head Tap Bolts

Full thread hex head bolts.



Machine Screws

We stock machine screws in many standard diameters.



Needle Point HWH SMS

Huge stock of needle point sheet metal screws, including painted!

SAFETY GEAR



SAFETY PENNANTS AND CAUTION/DANGER TAPE FALL PROTECTION KITS ROOFTOP SAFETY PERSONAL PROTECTIVE EQUIPMENT

SAFETY PENNANTS AND CAUTION/DANGER TAPE

 The Brush Man™



Safety Pennants

100' OSHA Pennant Flags

Available in:

Red | Red/Yellow | Yellow

 The Brush Man™



Rooftop Perimeter Cone w/Base

39" OSHA compliant tie off height. Stackable with or without base. Dimensions: 46" (H) X 4" Dia. (Top) X 7.5" Dia. (Bottom). Weight: 30 lbs.

 The Brush Man™



Caution and Danger Tape

Available Styles:

3" X 1000' Yellow Caution Tape

3" X 1000' Red Danger Tape

3" X 300' Red Danger Tape

FALL PROTECTION AND ROOFTOP SAFETY SYSTEMS



Safewaze Roofers Fall Prot. Kit

The SafeWaze V-Line FS-ROOF-E Fall Protection Kit includes a pass through leg harness, reusable roof anchor, and rope lifeline packaged in a bucket.



FallTech Professional Roofers Kit

Professional roofers kit contains harness, lifeline, lanyard with integral rope grab, packed in a bucket.



Fall Protection Accessories

Rope grabs, rope, lanyards and more available.



Tie Down Mobile Fall Protection

PENETRATOR Mobile Fall Protection by Tie Down is the only portable fall protection device with OSHA Compliant Safe Work Zones. Call your PRO branch for more great TIE DOWN Products.

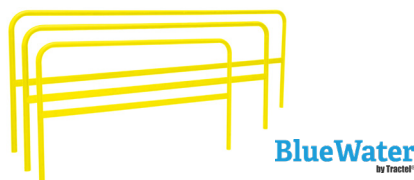

BlueWater GuardRails

PRO offers guardrail systems for order. Your PRO rep will help you select the system that is right for your company.

PERSONAL PROTECTIVE EQUIPMENT



Work Gloves

Each PRO branch stocks multiple style of work gloves. Call your PRO branch for your specific needs.



Safety Glasses

Need safety glasses? We've got you covered. Contact your local PRO branch for stock options.



Ear Plugs

Foam ear plugs, both corded and non-corded available.



25 Person First Aid Kit

Includes first aid instructions, bandages, scissors, forceps, exam gloves and more!



Hard Hats

We offer quality hard hats with multiple options, including custom logo orders.



Safety Vests

Keep your workers well seen with quality safety vests. We also can handle custom logo orders!

ACCESSORIES & TOOLS



BIT TIPS AND DRIVERS

SPECIALTY BITS AND DRIVERS

DRILL BITS

CONTRACTOR ACCESSORIES

CUTTING TOOLS AND BLADES - POWER TOOLS

BIT TIPS AND DRIVERS



Phillips Tips

Stock sizes include:

P-1 X 1" P-1 X 2" P-1 X 2 3/4"
 P-2 X 1" P-2 X 2" P-2 X 2 3/4" P-2 X 3 1/2"
 P-2 X 6"
 P-3 X 1" P-3 X 2" P-3 X 2 3/4" P-3 X 3 1/2"
 P-3 X 6"



Apex Premium Bits

Stock sizes include:

P-2 X 1" P-2 X 1" Reduced P-2 X 2"
 P-2 X 3 1/2"
 P-3 X 1" P-3 X 2" P-2 X 3 1/2"
 Apex Slotted Tips



Impact Ready Phillips Tips

Stock sizes include:

P-2 X 1" P-2 X 2" P-2 X 3 1/2"
 P-3 X 1" P-3 X 2"

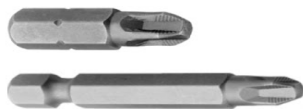

Phillips Square Drive (PSD)

Stock sizes include:

- P-1 X 1" P-1 X 2" P-1 X 2 3/4"
- P-2 X 1" P-2 X 2" P-2 X 2 3/4" P-2 X 3 1/2"
- P-2 X 6"
- P-3 X 1" P-3 X 2" P-3 X 2 3/4" P-3 X 3 1/2"
- P-3 X 6"



Square Drive Bits

Stock sizes include:

- #1 X 1" #1 X 2" #1 X 3"
- #2 X 1" #2 X 2" #2 X 2 3/4" #2 X 3 1/2"
- #3 X 1" #3 X 2" #3 X 2 3/4" #3 X 3 1/2"



Torx Bits

Stock sizes include:

- T-10 X 1" T-15 X 1" T-20 X 1" T-20 X 2" T-25 X 1"
- T-25 X 2" T-27 X 1" T-27 X 2" T-30 X 1" T-30 X 2"
- T-30 X 2 3/4" T-40 X 1"
- T-20 x 2" Impact Ready T-25 x 2" Impact Ready



Magnetic Nutsetters

Stock sizes include:

- 1/4" X 2 9/16" 1/4" X 4" 1/4" X 6"
- 5/16" X 2 9/16" 5/16" X 4" 5/16" X 6"
- 3/8" X 2 9/16" 3/8" X 4" 3/8" X 6"



Magnetic Bitholders

Stock sizes include:

- 2 1/4" 3" 6"



Magnetic Impact Sockets

Stock sizes include:

- 1/4" Drive X 1/4" 1/4" Drive X 5/16"
- 1/4" Drive X 3/8" 1/4" Drive X 1/2"

SPECIALTY BITS AND DRIVERS



Sammys Drivers

Stock sizes include:

- Sammy Super Screw #12 Jr Nut Driver
- Sammy Super Screw #14 Nut Driver (Black)
- Sammy Super Screw #14SW Sidewinder Nut Driver (Red)



GypTec Drivers

Stock sizes include:

- Standard 2" GypTec Driver



Carlisle Fastener Bits

Stock sizes include:

- #2 X 2" Carlisle Bit

DRILL BITS



Jobber Length HSS Drill Bits

Stock sizes include:

- #1 #2 #7 #10 #11 #21 #25 #30
- 3/32" 7/64" 1/8" 9/64" 5/32" 11/64" 3/16"
- 13/64" 7/32" 15/64" 1/4" 17/64" 9/32"
- 19/64" 5/16" 21/64" 11/32" 23/64" 3/8"
- 25/64" 7/16" 29/64" 1/2"



Stub Length HSS Drill Bits

Stock sizes include:

- #1 #2 #7 #10 #11 #21 #25 #30
- 3/32" 7/64" 1/8" 9/64" 5/32" 11/64" 3/16"
- 13/64" 7/32" 15/64" 1/4" 17/64" 9/32"
- 19/64" 5/16" 21/64" 11/32" 23/64" 3/8"
- 25/64" 7/16" 29/64" 1/2"



Double End HSS Drill Bits

Stock sizes include:

- #30
- 1/8" 9/64" 5/32" 3/16" 7/32" 1/4"

DRILL BITS CONTINUED



Aircraft Length Drill Bits

Stock sizes include (6" and 12"):

#1 #2 #7 #10 #11 #21 #25 #30

3/32" 7/64" 1/8" 9/64" 5/32" 11/64" 3/16"
13/64" 7/32" 15/64" 1/4" 17/64" 9/32"
19/64" 5/16" 21/64" 11/32" 23/64" 3/8"
25/64" 7/16" 29/64" 1/2"



Cobalt Aircraft Bits

Stock sizes include (6"):

#1 #7 #30

1/8" 5/32" 11/64" 3/16" 13/64" 7/32" 15/64"
1/4" 17/64" 5/16" 3/8"



Countersink Drill Bits

Stock sizes include:

#10

3/16" 3/8" 1/2" 5/8" 3/4"



Taps

Stock sizes include:

6-32 8-32 10-24 10-32 5/16"-18 3/8"-16



Masonry SDS Bits

We stock a HUGE selection of masonry drill bits from 3/16" diameter thru 1".



Tapcon Drill Bits

We stock specialty bits for masonry anchors like Tapcon.

CONTRACTOR ACCESSORIES



Chip Brushes

Stock sizes include:

Standard: 1/2" 1" 1 1/2" 2" 2 1/2" 3" 4"
Double Thick: 2" 3" 4"



Roller Frames

Stock sizes include:

Standard: 3" 4" 9"
Heavy Duty: 4" 9" 18"
Jumbo: 4" 9"
Lightweight: 9" 18"



Roller Covers

Stock sizes include:

Economy (3/8" Nap): 3" 4" 9"
Economy (1/2" Nap): 9"
Heavy Duty (3/8" Nap): 3" 4" 9"
Heavy Duty (1/2" Nap): 3" 4" 9"

More sizes and styles available per branch



Handles

Stock sizes include:

60" X 1 1/8" Wood Handle w/Tapered Tip
72" x 1-1/8" Wood Handle w/Tapered Tip
60" x 1-1/8" Wood Handle w/Metal Thread
72" x 1-1/8" Wood Handle w/Metal Thread
More sizes and styles available per branch



Floor Sweeps and Brooms

Stock sizes include:

Coarse Sweeps: 24" 36"
All-Purpose Floor Sweeps: 18" 24" 36"
Synthetic Fill: 18" 24"
More sizes and styles available per branch



Squeegees

Stock sizes include:

18" Serrated 3/16" Notch
18" Serrated 1/4" Notch
24" Floor Squeegee
30" Floor Squeegee
More sizes and styles available per branch



Garbage Bags

Stock styles include:

- 42 Gallon 3-mil
- 55 Gallon 3-mil



Rags / Clothes / Sweatshirts

Stock styles include:

- 5 Pound Box of Rags
- 10 Pound Box of Rags
- 10 Pounds Reclaimed White Sweatshirt Rags
- 10 Pounds White Cotton Sheet Rags



Clamp Kits

Stock styles include:

- Make A Clamp Kit (100 Ft.) With 25 Fasteners & 25 Splices
- Make A Clamp Kit (50 Ft.) With 10 Fasteners & 5 Splices
- Make A Clamp Kit (50 Ft.) With 50 Fasteners & 10 Splices



Duct Tape

Stock styles include:

- 2" X 60 Yard Contractor Grade Silver
- 2" X 60 Yard Contractor Grade Black



Cleaning Wipes

Stock styles include:

- Tub O' Towels (90 wipes)



Pallet Covers

Stock sizes include:

- 4' X 4' Tan 4' X 4' White
- 4' X 8' Tan 4' X 8' White



Hose Clamps

Stock styles include:

- Stainless Hose Clamps: 3/4"-1 3/4" 7/8"-2 3/8"
- 2"-8 1/2" 2"-12" 10"-12"
- Marine Grade: 3/4"-1 3/4" 4 1/8"-7"



Masking Tape

Stock sizes include:

- 2" Contractor Grade Masking Tape



Citrus Cleaners

Stock styles include:

- Aero-Gel 11 oz Degreaser
- Citrus Cleaner/Degreaser 1 Gallon



Powerblanket Cylinder Wrap

20 Pound Tank Gas Cylinder Heater

More sizes and styles available!



Safety Cans

Stock styles include:

- 1 Gallon Metal Gas Container w/Funnel
- 2 Gallon Metal Gas Container w/Funnel
- 5 Gallon Metal Gas Container w/Funnel
- 5 Gallon Diesel Fuel Container w/Funnel



Painters Tape

Stock sizes include:

- 2" Contractor Grade Blue Masking Tape

CONTRACTOR ACCESSORIES CONTINUED

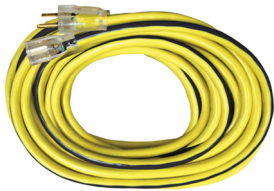

Extension Cords

Stock styles include:

Lighted-End: 12/3 X 25' 12/3 X 50' 12/3 X 100'

Tri-Source Lighted-End: 12/3 X 25' 12/3 X 50' 12/3 X 100'

More sizes and styles available per branch

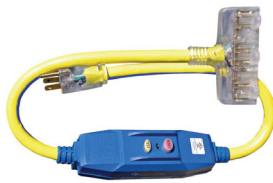

GFCI Tri Tap (20 Amp)

Stock styles include:

12/3 X 2' Extreme Temp

12/3 X 3' Standard



Spray Paint

Stock styles include:

Upside Down Marking Paint, 20 oz.

Tough Coat Spray Paint, 16 oz.

CUTTING TOOLS AND BLADES



Retractable Utility Knives

Contractor grade utility knives.

More sizes and styles available per branch

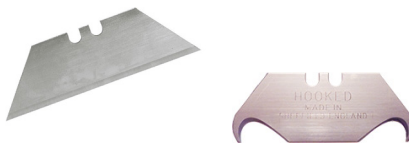

Utility Blades

Stock styles include:

Utility (Razor) Blades

Deep Hook Blades



Pipe Knife Replacement Blades

Stock styles include:

PipeKnife Angled Blade

PipeKnife Serrated Razor Blade



Aviation Snips

Stock styles include:

Left Offset Aviation Snips

Right Offset Aviation Snips



Lenox Reciprocating Saw Blades

Stock styles include:

Wood Cutting Metal Cutting General Purpose

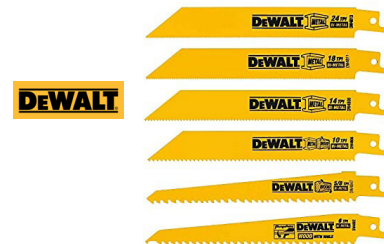

DeWalt Reciprocating Saw Blades

Stock styles include:

Wood Cutting Metal Cutting General Purpose



FLEXOVIT

Flexovit Chop Saw Blades

Stock styles include:

12" Metal and Concrete Cutting

14" Metal and Concrete Cutting



Cut-Off Wheels

Stock styles include:

4 1/2" Metal and Concrete

6" Metal and Concrete

7" Metal and Concrete

9" Metal and Concrete



MORSE

Metal Cutting Saw Blades

Stock styles include:

7" Metal Cutting

9" Metal Cutting

Check out the Metal Devil Saw on page 35!

POWER TOOLS



DeWalt DW268 VSR Screwgun

The DW268 2,500 rpm VSR VERSA-CLUTCH™ Scrugun is constructed with helical-cut steel and heat-treated steel gears for long life and durability. Rubber grip and two-finger trigger provides comfort and control.



DeWalt DW284 VSR Screwgun

The DW284 2,500 rpm VSR Positive-Clutch Scrugun with Threaded Clutch Housing is built tough, yet it is lightweight to increase endurance. Gives user more control with two-finger trigger and increases productivity with a positive clutch.



DeWalt DCF622M2 20V Screwgun

The DEWALT 20V MAX* DCF622 Screwgun with Versa-Clutch™ features a DEWALT built brushless motor capable of up to 2,000 RPMs delivering the torque needed for heavier duty fastening applications.



DeWalt DCF620 20V Drywall Gun

The 20V MAX* XR® Brushless Drywall Screwgun is a cordless solution for installing drywall and uses the same battery and charger as your other 20V MAX* tools. This cordless screwgun provides greater speed than the DW272 corded screwgun, with up to 4,400 RPM. The nose cone locks on securely and can be adjusted to 3 different screw depths. To drive screws more quickly, use the compatible DCF6201 Collated Magazine Attachment with this screwgun.



DeWalt D25133K 1" SDS

The D25133K 1" SDS+ Pistol Grip Hammer is a high performance drill with 2.6 joules of impact energy. The reverse feature assists in the removal of stuck drill bits with a full-speed rotating brush ring that delivers equal power in forward or reverse.



DeWalt D25263K 1 1/8" Rotary

D25263K 1-1/8" SDS+ Rotary Hammer Kit is a light weight, low vibration, high-performance drill designed for demands of today's contractor. The durable German engineered mechanism delivers 3.0 joules of impact energy that delivers up to 15% faster speed of application that professionals demand. The Active Vibration Control® technology employed delivers reduced user vibration for less user fatigue and greater productivity.



DeWalt DCH133B 20V Hammer

The 20V MAX* Brushless 1 in. Rotary Hammer is a high-performance drill powered by a brushless motor and a durable German engineered mechanism, delivering 2.6 Joules of impact energy. The lightweight design makes this tool ideal for forming, rod hanging, structural connections, beam & column anchorage, steel stanchion mounting, and clip & bracket mounting. This hammer features a rotating dial to set the tool to a specific application mode - drill, hammer drill, or chip.



DeWalt DCH273B 20V Hammer

The 20V MAX* XR Brushless 1 in. Rotary Hammer is a high-performance drill powered by a brushless motor and a durable German-engineered mechanism, delivering 2.1 Joules of impact energy. The lightweight design makes this tool ideal for rod hanging, seismic & safety attachments, cable tray & strut mounting, clamp mounting, and rail mounting. It is part of the PERFORM and PROTECT™ product line, integrated with the SHOCKS ACTIVE VIBRATION CONTROL® System and becomes OSHA Table 1 Compliant when used with the DWH303DH On Board Extractor.



DeWalt DCD996P2 20V Hammer

This 20V MAX* cordless kit includes one 1/2 in. hammer drill/driver, two 20V MAX* 5.0Ah batteries, charger, and hard case. This hammerdrill comes equipped with a heavy-duty ratcheting nitro-carburized metal chuck with carbide inserts for superior bit gripping strength and a high efficiency brushless motor that delivers up to 57% more runtime over brushed. The DCD996 features a 3-mode LED providing light in dark or confined spaces and is 20X brighter than the previous model.

POWER TOOLS CONTINUED



DeWalt DWE402 Angle Grinder

The DWE402 4-1/2" (115mm) Small Angle Grinder features three powerful systems for maximizing performance such as the Dust Ejection System for preventing damaging dust from entering the tool, One-Touch Guard™ for 360-degree rotation, and Quick-Change™ Wheel Release for easy wheel removal.



DeWalt DCG412B 20V Grinder

The DCG412B 20V MAX* Lithium Ion 4-1/2" / 5" Grinder increases productivity with features like Quick-Change™ wheel release, convenient trigger switch with lock-off button, and extended run-time battery.



DeWalt DCF850B 20V Impact

At less than 4 in. in length, the Atomic 20V MAX* 1/4 in. Brushless Cordless 3-Speed Impact Driver can handle tight applications like narrow cabinetry or framing without the need for an additional tool. Though the Impact Driver is lightweight and compact in size, it does not sacrifice performance with its brushless motor that delivers up to 1,825 in-lb of torque and 3,250 rpm for driving large-diameter screws. Illuminate dim workspaces for enhanced visibility with the 3-LED on-board work light and keep your workflow consistent.



DeWalt DCF887B 20V Impact

The DCF887B 20V MAX* XR® Brushless 1/4" 3-Speed Impact Driver is compact for fitting in tight spaces and increasing productivity. Three LED lights make it ideal for working in dark spaces. Tool only. Kit also available.



DeWalt DCS380B 20V Recip Saw

The DCS380B 20V MAX* Reciprocating Saw has a variable speed trigger delivering up to 3000 strokes per minute allowing you to match speed with application and a 1-1/8" stroke length for fast cutting. The keyless lever-action 4-position blade clamp makes changing blades quick and easy and allows for a variety of applications including flush cutting. The pivoting shoe provides leverage during cutting and extends blade life. Battery and charger sold separately.



DeWalt DWE305 12 Amp Recip

The DWE305 Reciprocating Saw has a powerful 12 Amp motor with a variable speed trigger that provides up to 2,900 strokes per minute with a 1-1/8" stroke length for fast cutting. Features a keyless, lever-action 4-position blade clamp for quick and easy blade changes in 4 directions for a variety of applications including flush cutting.



DeWalt DWE575SB 7 1/4" Saw

The DWE575 7-1/4 in. Lightweight Circular Saw is among the lightest saws in its class at only 8.8 lbs. 15 Amp motor is powerful enough for the toughest applications and electric brake stops the blade after trigger is released. Bevel capacity of 57° and 2-9/16 in. depth of cut capacity provide versatility.



DeWalt DC560B 20V Caulk Gun

Variable Speed Trigger allows for increased control over the flow of your adhesive. Anti - Drip Feature automatically retracts the plunging rod once trigger is released preventing excess adhesive from dripping out. Quick Connect inter-changeable canister trays allows user to quickly change between canister sizes. LED light assists users with visibility in low light situations.

Sausage and Quart tools also available!



DeWalt DCV517B 1/2 Gallon Vac

The 20V MAX* 1/2 Gallon Wet/Dry Portable Vacuum runs off all 20V MAX* battery packs for long runtime. The HEPA wet/dry filter traps 99.97% of dust at 0.3 microns. Dual clean-up modes allow for debris removal with either the front utility nozzle or extendable rubber hose. The portable vacuum is easy to use with a heavy duty tank latch for emptying and cleaning, a large on/off switch for one-hand access, and a heavy-duty rubber hose that provides durability and flexibility.

NOT ALL TOOLS ARE STOCKED AT EACH BRANCH - CONTACT YOUR PRO BRANCH FOR CURRENT STOCK

INDEX

A

| | |
|------------------------------------|----|
| ACM Screws | 11 |
| Above grade waterproofing products | 43 |
| AccuTrac plates | 26 |
| AccuTrac system | 34 |
| Adhesive sealants | 15 |
| Aircraft bits | 58 |
| APOC roof cements and mastics | 33 |
| Assembled screws and plates | 26 |
| Aviation snips | 60 |

B

| | |
|------------------------------------|-------|
| Backer rod | 19 |
| Below grade waterproofing products | 42 |
| Bi-Flex Structural Drill Screws | 9 |
| Bit tips and drivers | 56-57 |
| BlueWater GuardRails | 55 |
| Bond breaker tape | 19 |
| Bulb-Tite rivets | 45 |
| Butler Bolts | 11 |

C

| | |
|--------------------------|-------|
| Caulking accessories | 20-21 |
| Caution tape | 54 |
| Caulk guns | 20 |
| Caulk warmers | 21 |
| ChemLink | 30 |
| Chip brushes | 58 |
| Clamp kits | 59 |
| Cleaning supplies | 59 |
| Concrete fasteners | 46-48 |
| Construction chemicals | 43 |
| Custom in-house painting | 9 |
| Cutting tools and blades | 60 |

D

| | |
|-----------------------------------|-------|
| Danger tape | 54 |
| Dec-King | 51 |
| Dektite | 30 |
| Denver foam | 19 |
| DeWalt power tools | 61-62 |
| DOW silicones | 14-15 |
| Dril-Flex Structural Drill Screws | 8 |
| Drill bits | 57-58 |
| Drip edge | 21 |
| Drop-in anchors | 48 |
| Drywall screws | 51 |
| Duct tape | 59 |
| Dymonic 100 | 13 |
| Dymonic FC | 13 |

E

| | |
|--------------------------|-------|
| EMSEAL | 19 |
| Epoxy anchors | 49 |
| ER Systems roof coatings | 36-37 |
| EternaBond products | 32 |
| Extension cords | 60 |
| EZ Anchors | 51 |

F

| | |
|----------------------------|----|
| FAB-LOK | 45 |
| Fall protection products | 55 |
| Fire Rated Sealants | 16 |
| Flatwashers | 53 |
| Floor sweeps and brooms | 58 |
| Fluid applied air barriers | 39 |
| Froth-Pak | 24 |

G

| | |
|---------|----|
| GE 1000 | 15 |
|---------|----|

| | |
|------------|----|
| Gripple | 53 |
| GypFast G2 | 50 |

H

| | |
|---------------------------------|-------|
| Hammer drills | 61 |
| Heavy duty self-drilling screws | 8 |
| Henry Blueskin products | 40-41 |
| Hex head cap screws | 53 |
| Hex nuts | 53 |
| HER Sealant | 37 |

I

| | |
|--------------------------|----|
| Inland Coatings products | 37 |
| IPCO products | 41 |

J

| | |
|--------------------------|----|
| Jobber length drill bits | 57 |
|--------------------------|----|

K

| | |
|------------------|----|
| Klik-Lock rivets | 45 |
|------------------|----|

L

| | |
|---------------------------------------|--------|
| Lag screws | 53 |
| Lath head (round washer head) | 10, 51 |
| LEF Foam | 17 |
| Liquid applied flashings and sealants | 39-40 |
| Lockin' Pockets | 30 |
| Low profile head fasteners | 10 |

M

| | |
|----------------------------------|-------|
| Maxiseal TEKS | 7 |
| Medium duty self-drilling screws | 6-7 |
| Metal cutting blades | 60 |
| Metal Devil saw | 35 |
| Metal to wood fasteners | 10 |
| Millennium roof adhesive | 23-24 |

N

| | |
|-------------|----|
| Neo Washers | 11 |
| Nose cones | 20 |
| NP-1 | 13 |

O

| | |
|------------------|----|
| OlyBond products | 23 |
| OMG roof drains | 30 |

P

| | |
|-----------------------------------|-------|
| Pace Cart 3 | 34 |
| Painted rivets | 45 |
| Pallet covers | 59 |
| PPE | 55 |
| PF Flyers 10-16 X 3/4 drill screw | 6 |
| Pipe knives | 20 |
| Pipe Supports | 30-31 |
| Polyurethane expansion foam | 17 |
| Polyurethane sealants | 13 |
| Powder actuated | 49 |
| Pre-assembled roofing fasteners | 26 |
| Primers | 17 |
| PROFILERS low profile fasteners | 10 |
| PROSOCO products | 43 |

R

| | |
|--------------------------|-------|
| Ramset gas tools | 50 |
| Reciprocating saw blades | 60 |
| RhinoBond products | 33 |
| Rivet installation tools | 45 |
| Rivets | 44-45 |
| Roller frames and covers | 58 |
| Roof coatings | 36 |

| | |
|-----------------------------|-------|
| Roof drains | 30 |
| Roof flashings | 30 |
| Roof repair sealants | 32 |
| Roof repair tapes | 31-32 |
| Roofing insulation adhesive | 23 |
| Roofing insulation plates | 26-27 |
| Roofing membrane plates | 26-27 |
| Roofing screws | 25 |

S

| | |
|--------------------------------------|-------|
| Safety pennants | 54 |
| Sammys suspended anchoring | 53 |
| Saw blades | 60 |
| Screw guns | 61 |
| ScruBolts | 11 |
| SDS bits | 58 |
| Self-tapping fasteners | 11 |
| Sheet applied air barrier products | 40-42 |
| Sheet metal screws | 53 |
| Shims | 20 |
| Silicone sealants | 14 |
| SIP fasteners | 29 |
| Spectrem silicones | 14 |
| SL-1 | 13 |
| Spatulas | 21 |
| Specialty bits and drivers | 57 |
| Specialty roofing fasteners | 28-29 |
| Specialty sealants | 16 |
| Stainless roofing screws | 25 |
| Stainless steel self-drilling screws | 7-8 |
| Stainless tappers | 11 |
| Strut | 52 |
| Stub length drill bits | 57 |

T

| | |
|--------------------------------|----|
| T4MAG tool | 50 |
| Tapcon | 47 |
| Tape | 59 |
| Tape (butyl) caulk | 19 |
| Tappers | 11 |
| TEKS 1 fasteners | 7 |
| TEKS 5 fasteners | 8 |
| TermPRO | 35 |
| Termination bar | 29 |
| Threaded rod | 52 |
| TieDown Mobile Fall Protection | 55 |
| Traffic and deck coating | 18 |
| TrakFast | 50 |
| TriggerFoam | 17 |
| TruFast roofing adhesive | 23 |
| TruGrip fasteners | 10 |
| Tundra Foam | 19 |

U

| | |
|-----------|----|
| ULTRACON+ | 46 |
| Unistrut | 52 |

V

| | |
|------------|----|
| Versi-Foam | 24 |
| Vulkem 116 | 13 |

W

| | |
|-----------------------------|----|
| Water repellents | 43 |
| Wood to metal self-drillers | 11 |
| Woodgrip 304SS | 10 |

Z

| | |
|---------------|----|
| Zamac Nailins | 47 |
|---------------|----|

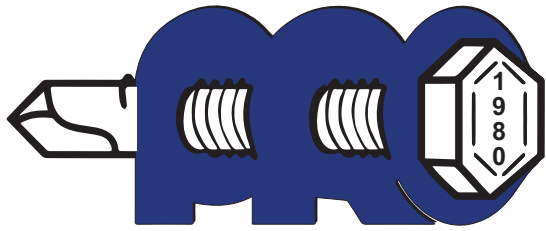

PRO FASTENING SYSTEMS, INC.

WWW.PROFASTENING.COM

***PROUDLY SUPPLYING PROFESSIONAL
CONTRACTORS SINCE 1980***

SELF-DRILLING SCREWS - SELF-TAPPING SCREWS
SEALANTS - COMMERCIAL ROOFING PRODUCTS
ROOF COATINGS - BUILDING ENVELOPE PRODUCTS
RIVETS - CONCRETE FASTENING - DRYWALL PRODUCTS
HARDWARE - SAFETY GEAR
CONTRACTOR ACCESSORIES AND POWER TOOLS

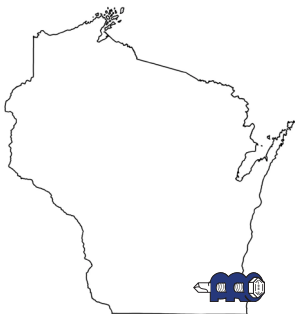

PRO FASTENING SYSTEMS, INC.
6418-A S. HOWELL AVE.
OAK CREEK, WI 53154
414-764-1246
BEN@PROFASTENING.COM



PRO FASTENING SYSTEMS, INC.
44 E. UNIVERSITY DR.
ARLINGTON HEIGHTS, IL 60004
847-577-7185
DON@PROFASTENING.COM

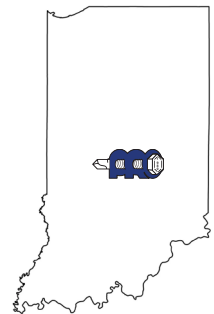

PRO FASTENING SYSTEMS, INC.
8140 ZIONSVILLE ROAD
INDIANAPOLIS, IN 46268
317-872-6620
JIM@PROFASTENING.COM

INK SMITH, INC. A PRO FASTENING SYSTEMS Co.
3352 N. MILWAUKEE AVE.
CHICAGO, IL 60641
773-777-5825
SALES@INKSMITHINC.COM